

Pellet boiler

PELLUX SLIM 12

PELLUX SLIM 18

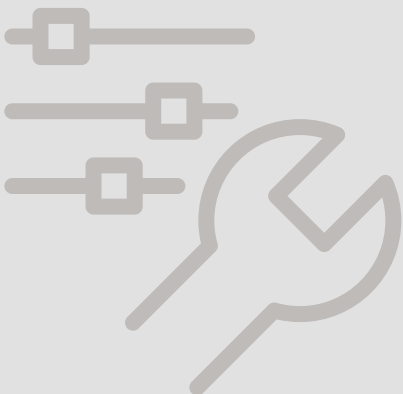
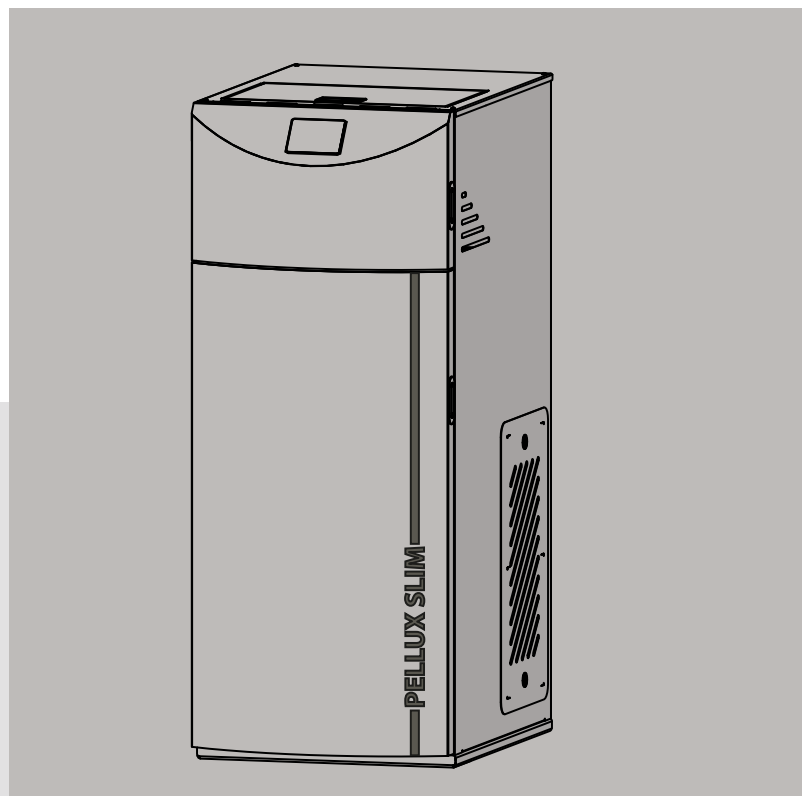

Information for the User

We recommend the following steps after the consumption of 300 kg of pellets:

1. Check the ash container and the combustion chamber. If necessary, empty the ash drawer and clean it. Clean the chamber of soot and ash using a vacuum cleaner.
2. Check the burner grate. If you find ash or deposits there, clean the grate (including air holes).
3. Check the bottom of the pellet tray. If dust has accumulated there clean it.
4. Use only high quality wood pellets of a diameter from 6 to 8 mm and a maximum length of 30 mm.

Dataplate is located on the side housing.



IMPORTANT

In summer, the boiler must remain connected to the power supply - to reduce the risk of condensation in the panel. To stop the boiler operation, turn off the heating circuits on the regulator.

| | | |
|--|--|-----------------------------|
| <small>NIBE-BIAWAR sp. z o.o. 15-703 Białystok, Al. Jana Pawła II 57</small> | | |
| PELLUX SLIM 12 | | 069235 |
| | | 1/N/PE 230V, 50Hz, 10A IP21 |
| Q | | 3,5-12,1 kW |
| P _{QN} | | 90 W |
| P _{Qmin} | | 30 W |
| T _{max} | | 90 °C |
| PS | | 2,0 bar |
| V | | 38 L |
| C (EN 303-5) | | 5 |
| F | | C1 |

| Symbol | Description |
|-------------------|---|
| PELLUX SLIM 12 | Type of boiler |
| IP 21 | Degree of protection |
| Q | Range of heating power |
| P _{QN} | Power consumption at nominal power |
| P _{Qmin} | Power consumption at minimum power |
| T _{max} | The maximum operating temperature |
| PMS | Maximum working pressure |
| V | Water storage capacity |
| C (EN 303-5) | Boiler class according to the EN 303-5 |
| F | Basic fuel |
| | The CE marking |
| | Sign electro recycling - waste |
| | Sign indicating the need to read the manufacturer's information |

The product is not intended for use by persons with reduced physical fitness/mental efficiency or without experience and knowledge, if they are not supervised or instructed by a person responsible for their safety. Operation of the product by children is strictly prohibited.

All installation diagrams in this manual do not replace the system design; they can only be used for illustrative purposes.

We reserve the right to make the product design changes and changes in the manual.

©NIBE-BIAWAR 2021

List of contents

| | | | |
|---|-----------|--|-----------|
| 1 General | 4 | 9 Maintenance and Troubleshooting | 18 |
| Equipment | 4 | General | 18 |
| Accessories | 4 | Burner | 18 |
| 2 Symbols | 5 | Soot and Ash Removal | 18 |
| 3 Information regarding safety | 5 | Causes of Failure and Remedy | 19 |
| Installation - location of the boiler | 5 | 10 General Information for Installers | 20 |
| Electrical Installation | 5 | Location of the Boiler | 20 |
| Heating System | 5 | Chimney – Requirements | 20 |
| 4 Installation | 6 | 11 Connection to the System | 22 |
| Intended Use | 6 | 12 Electrical connections | 23 |
| Product description | 6 | Direct Connection of the Units | 23 |
| System diagram | 6 | Connection | 25 |
| Heating | 6 | Internal Overvoltage Protection | 25 |
| Hot Utility Water Treatment | 6 | Control Panel Connection | 25 |
| 5 Control Panel | 7 | 13 Boiler settings | 29 |
| Start-Up and Shutdown | 8 | 14 Service | 33 |
| Operating Modes | 9 | Service settings | 37 |
| Firing up | 9 | Software update | 44 |
| Incandescence | 9 | Loss of Voltage | 44 |
| Operation | 9 | Anti-Frost Protection | 44 |
| Supervision | 10 | Pump Protection Against Sticking | 44 |
| Burning off | 10 | Fuse Replacement | 44 |
| Stop | 10 | Replacement of the Control Panel | 44 |
| CHIMNEY SWEEP mode | 10 | Connecting Accessories | 45 |
| Menu główne - Użytkownika | 11 | Boiler (STB) and Feeder | 47 |
| 6 Heating | 13 | Temperature Limiters | 47 |
| General | 13 | Cleaning | 48 |
| Basic Modes of Operation of the Boiler | 13 | Periodic cleaning of the boiler | 49 |
| Weather-Based Control | 14 | Alarms | 51 |
| Selecting the heat source for the mixer | 15 | 15 Wiring Diagrams | 52 |
| Return protection 3-way | 15 | Boiler | 52 |
| Return protection 4-way | 15 | 16 Location of Components | 53 |
| 7 Hot Utility Water | 16 | Electrical Components | 55 |
| Hot Utility Water (HUW) Settings | 16 | 17 Dimensions | 56 |
| HUW tank disinfection | 16 | 19 Technical Specifications | 57 |
| Setting of the HUW Temperature Setpoint | 16 | | |
| The HUW tank hysteresis | 16 | | |
| HUW Circulation | 16 | | |
| Activation of the summer feature | 16 | | |
| 8 Other Boiler Settings | 17 | | |
| Fuel Level Configuration | 17 | | |
| Information | 17 | | |
| Manual Control | 17 | | |
| Cooperation with the room panel | 17 | | |
| Cooperation with the internet module | 18 | | |

1 General

Thank you for your confidence in us and our product, we also congratulate you on your choice of the Pellux boiler. In order to achieve the highest efficiency and safe working conditions, please read this Installation & Operating Manual carefully and comply with the recommendations and observations contained in it.

The Pellux Slim boiler is designed to operate in open or closed systems. Please note that the system has to be protected in accordance with the applicable regulations. For the boilers operating in an open and closed systems, protection of the system must be in accordance with local regulations. Pellux Slim's can be used in residential single and multi-family buildings, guest houses, department stores, etc.

The basic boiler fuel is a modern, eco-friendly fuel in the form of wood pellets. A burner used in the unit ensures minimum pellet consumption in relation to the thermal power received, resulting in fuel-efficient and comfort operation of the boiler.

The Pellux boiler has a compact design and operational solutions adapted to streamline its operation. With the enhanced electronic control, you can control many parameters of the unit, adjusting it to different installation conditions and individual needs.

This Manual applies to the Pellux Slim 12 boiler and the Pellux Slim 18 boiler.



ADVICE

Certificates confirming the possession of the 5th class according to the EN 303-5: 2012 standard and compliance with the Ecodesign requirements are available on the website www.pellux.pl.

Equipment

The Pellux Slim boiler is equipped with the following set components:

- CT4 temperature sensor, L=3m (2 pce.)
- Wire with connector (1 pce.)
- Weather temperature sensor CT6-P (1 pce.)
- User's Manual (1 pce.)

Accessories

The Pellux Slim boiler can be equipped with additional accessories that are not part of the boiler kit. Below is a list of available accessories:

- Internet module ecoNET300
- Room temperature controller ecoSTER TOUCH
- Expansion module B/C
- Lambda probe module assembly
- Wireless room thermostat eSTER_x40
- Wireless room panel eSTER_x80
- Automatic cleaning kit

2 Symbols



IMPORTANT

This symbol informs about the risk to the device or a person.



CAUTION

This symbol points to important information to be noted when operating the device.



ADVICE

This symbol shall mean tips to make product operation easier.

3 Information regarding safety



IMPORTANT

Before starting the installation and use of the boiler, read the entire contents of this manual thoroughly. The manufacturer shall not be held liable for damages caused by non-observance of this manual.



IMPORTANT

PELLUX Slim boiler may only be installed by competent and qualified personnel, in accordance with applicable regulations, standards and manufacturer's recommendations. Failure to follow these instructions may void your warranty.



IMPORTANT

Use only original spare parts and accessories. The manufacturer takes no responsibility for damages resulting from the use of parts from other manufacturers.

Observation of the following safety rules is the basic condition for safe boiler operation:

- the boiler should be used as intended and kept in good condition (regular cleaning);
- always use the fuel recommended by the manufacturer;
- all boiler installations should have the necessary safety systems in accordance with applicable regulations;
- never insert any objects and limbs into moving parts in the boiler (feeder, turbulators, burner, etc.);
- never insert any objects and limbs in the rear part of the boiler with electrical devices when the boiler is connected to the power supply;
- use safety gloves to operate the boiler;
- maintain cleanliness and adequate lighting in the boiler room;
- first start-up of the boiler should be carried out by an authorized installer/ service technician.

Installation - location of the boiler

- The boiler should be installed in accordance with current standards.
- The boiler room should have adequate air Exchange rate.
- Ventilation ducts should be made of non-flammable materials.



CAUTION

The smoke conduit should undergo technical inspection and acceptance by a chimney sweep before installation.

Electrical Installation



IMPORTANT

The electrical installation, to which the boiler will be connected, should be made in accordance with current regulations.

- The electrical installation and any service of it may only be performed by a person with appropriate certifications and qualifications. Electrical installation and cable routing must be carried out in accordance with applicable regulations.
- The installation should always be made with a protective conductor..

Heating System

- The hydraulic and heating system must meet the requirements of applicable standards and legal regulations.



IMPORTANT

Flush the system before connecting the boiler to remove any small impurities that may damage the boiler or pumps.

4 Installation

Intended Use

The Pellux Slim heating boiler is designed for heating single and multi-family residential buildings or public buildings.

Product description

The boiler is designed to burn wood pellets. The vertical convection system and the soot removal system from the combustion tubes facilitate its cleaning. This ensures a high and equal level of energy efficiency. A ash pan facilitates the daily maintaining of cleanliness. The fuel is transported from the integrated container by an automatic fuel feeding system. The boiler regulator is responsible for the fuel supply and the burner operation. The fuel combustion process takes place with the participation of air supplied by a blower fan. Exhaust gas is removed by means of an exhaust fan installed in the boiler.

System diagram

UWAGA
This is a schematic representation only. The actual diagram of the system should be developed by an individual qualified to do so, in compliance with all standards and regulations

The system can be expanded up to:

- 5 heating circuits
- hot utility water treatment circuit
- heating system control with heat accumulation tank– a buffer
- control of the domestic hot water circulation pump

Heating

The heating medium is discharged to the heating system through outlet located on the back of the boiler.

Hot Utility Water Treatment

The boiler can be equipped with an internal circulation DHW pump to which you can connect an external DHW heat exchanger.

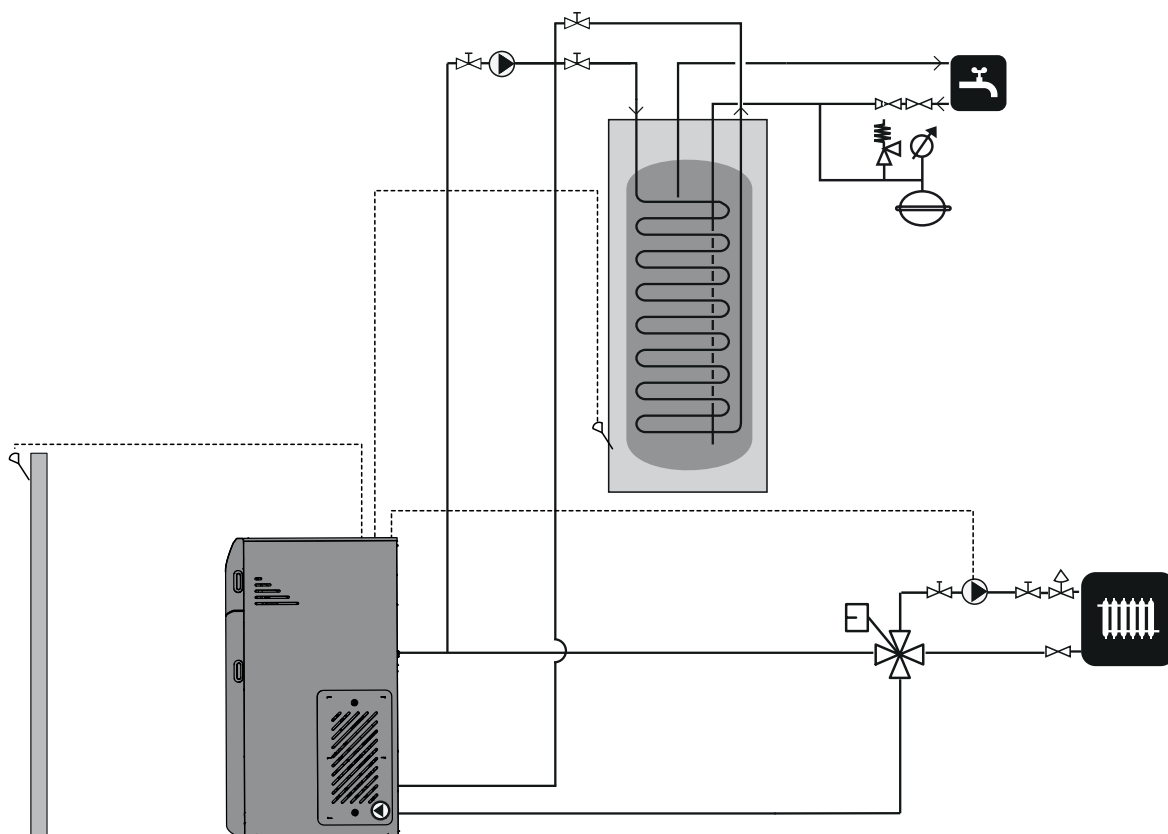

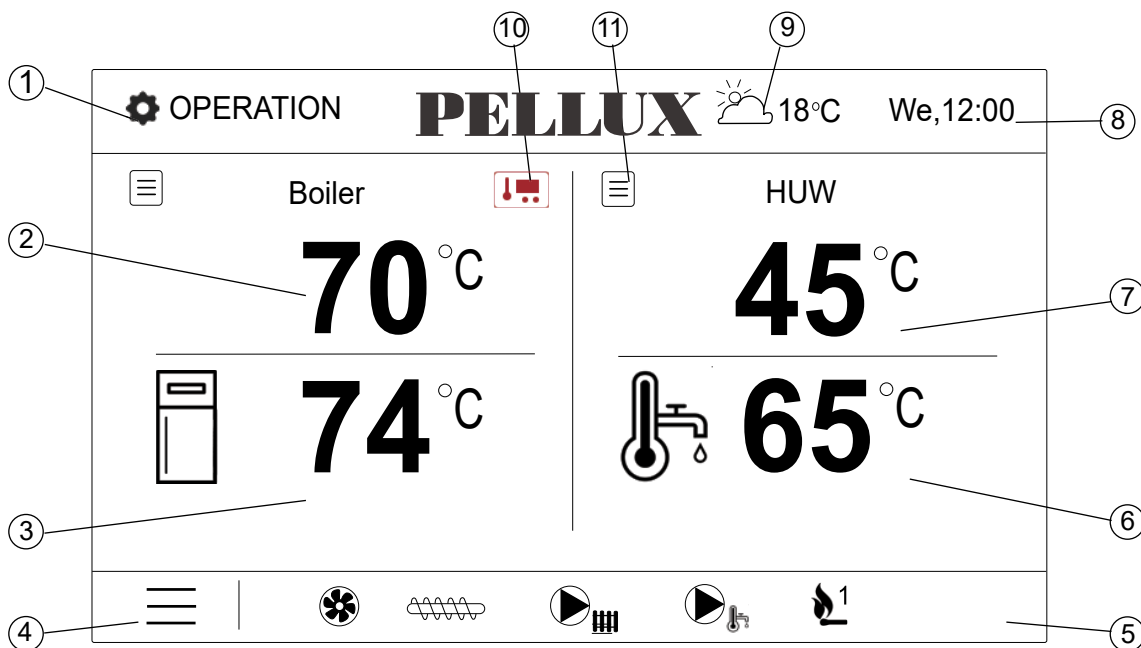

5 Control Panel



DESCRIPTION:

1. Operating modes:
 - INCANDESCENCE
 - FIRING UP
 - OPERATION
 - SUPERVISION
 - BURNING OFF
 - STOP
 - CHIMNEY SWEEP mode.
2. Boiler temperature setpoint, press and hold to edit the value,
3. Boiler measured temperature,
4. Press to enter the menu list,
5. Information bar::

 Fan operation [% or rpm]

 Feeder operation

  Pump operation

 Igniter operation

 Run of standby boiler

6. HUW tank temperature setpoint,
7. HUW tank temperature setpoint; hold it for a longer time to enter into editing of the value,

8. Time and day of the week,
9. Outdoor temperature (weather),
10. Other symbols:

 Opening of the room thermostat contacts – room temp. setpoint has been achieved

 Temperature setpoint drop from the active intervals

 Temperature setpoint increase during filling the hot utility water (HUW) tank

 Boiler temperature setpoint increase by the mixer circuit

 Active return protection

 Temperature setpoint increase when filling the buffer

 Weather control for boiler circuit switched on or mixer circuit

 Run of standby boiler

11. Quick entry to the set temperature editing menu: boiler, HUW tank, mixer circuit

Both left and right window on the Home panel may display various information. By touching the screen, you can toggle between the following information displayed: mixer circuits, information panel, hot utility water panel and fuel level panel.

Tip: The fuel level can also be seen in the room panel.

Start-Up and Shutdown

The burner is fully automatic, i.e. it automatically fires up and extinguishes, and does not require manual start-up and adjustment during operation. The process of firing pellets in the burner is initiated by the boiler controller.

Start-Up

Before the first start-up of the burner (or if you run out of fuel), fill the auger with pellets. This is done by filling the storage bin with pellets, and then switching the feeder function to the „On” position in the Manual Control. When filling, extend the grate in the Manual Control and let the pellets fall through the burner into the ash container so that they can be thrown back into the storage bin. Leave the feeder running for 3 minutes.

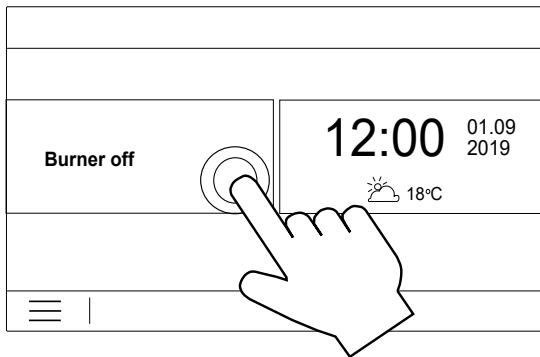

1. In order to start the boiler, press on any point on the control panel containing the text Burner Off. A request 'Activate regulator?' appears; confirm your selection by pressing on the ✓ mark. You can also use another boiler start-up procedure: press on MENU and find and press on the 🔥 button on the rotating menu.
2. After starting the boiler there will be PURGE. The regulator analyzes the flue gas temperature, if the temperature does not change by a given difference (delta), the boiler will start CLEANING. If the delta is exceeded, PURGE will continue until the temperature stabilizes.
3. After CLEANING, the status of FIRING UP is shown on the display of the operator panel.
 - The pellets are supplied to the burner at a specific dose (default for Pellux Slim 12 boiler is 100g, for Pellux Slim 18 - 140g)
 - Igniter is activatedThe order in which the feeder and heater are started depends on the time of feeding the starting dose of fuel.
 - After the heating-up time has elapsed, the fans are turned on.
 - After flame detection, the igniter turns off automatically.
4. The boiler goes into the INCANDESCENCE mode

5. After completing the INCANDESCENCE procedure, the boiler switches to OPERATION mode.



IMPORTANT

The standard fire up process takes approx. 9 min. If no flame is detected within this time, the igniter will try again 3 times. When flame still cannot be detected after 3 attempts, the emergency procedure is initiated (Ignition failed) and the fire up process is interrupted.

Shutdown

1. In order to stop the boiler operation, press on MENU and find and press on the 🔥 button on the rotating menu.
2. The control panel displays the BURNING OFF status.
3. The pellet feeder stops.
4. The burner air blower operates until detecting the noflame status.



IMPORTANT

The burner may still operate after switching the controller OFF (damping a fire), depending on the previous status. Do not interrupt this condition. If the unit is to be disconnected from the mains, wait until the fire extinguishing process ends up and the burner status shifts to the BURNER OFF status.

Operating Modes

| Status | Description |
|---------------|---|
| FIRING UP | Supply of an initial dose of fuel, start of the lighter and blower. Fuel fire up. |
| INCANDESCENCE | After detecting the flame in the firing up, the feeder continues to work, the blower power is increased to heat up the furnace. |
| OPERATION | Boiler goes into the constant duty cycle as specified by default or by the user. |
| SUPERVISION | The continuous operation duty cycle of the boiler in longer intervals, not allowing the damping. |
| BURNING OFF | Damping of the furnace. Air blower operates until complete disappearance of flame. |
| STOP | The burner is not working, but it is approved for operation. The required boiler temperature has been reached. |

Firing up

The FIRING UP mode is used for the fire up of the boiler furnace in auto mode. Parameters affecting the fire up process are grouped in the menu:

Service Settings → Boiler Settings → Firing Up

If the furnace fire up fails, there are further attempts to ignite performed. These fire up attempts are indicated by numbers at the igniter symbol.

The Firing up attempt failed is reported after three unsuccessful attempts. Automatic operation of the boiler may not be continued – the boiler operator has to intervene. Restart the boiler after remedying the cause for the fire up failure.

Incandescence

After detecting a flame in the firing up phase, there occurs an incandescence of the furnace before serving the next portion of fuel in the time specified by the Incandescence time parameter and increasing the blowing power. Parameter is in the menu:

Service Settings → Boiler Settings → Firing Up

Operation

The air blower operates in continuous mode. The fuel feeder operates in cycles. A cycle consists of the feeder operation time and a break time.

Parameters that affect the burner output: feeder operation time, airflow time and feeder operation time.

They can be found at:

Service Menu → Boiler Settings → Output Modulation

Setting the Temperature Setpoint

You can set the boiler temperature setpoint as well as the mixer circuit temperature setpoint from the menu level:

Boiler Settings → Preset Boiler Temperature

HUW settings → HUW preset temperature

Mixer 1-5 settings → Preset mixer 1-5 temperature

The controller can automatically increase the boiler temperature setpoint in order to be able to fill the hot utility water tank or supply the mixer heating circuits.

Regulation modes

There are two control modes available that are responsible for the boiler temperature setpoint stabilization, i.e.:

1. Standard
2. Fuzzy Logic

If the boiler temperature reaches or exceeds the setpoint value by the hysteresis value, the boiler goes into the SUPERVISION or BURNING OFF mode.

Service Menu → Boiler Settings → Output Modulation → Regulation Mode

Operation in Standard Mode

If the boiler temperature reaches or exceeds the setpoint value by the hysteresis value, the boiler goes into the SUPERVISION or BURNING OFF mode. The controller includes a mechanism for the boiler output modulation and allowing gradual reduction of it when the boiler temperature comes closer to the setpoint value. There are three output levels predefined:

- maximum output, 100%,
- medium output, 50%
- minimum output, 30%.

Various fuel supply times and airflow outputs can be assigned to these levels. The output level parameters are available in the menu:

Service Menu → Boiler Settings → Output Modulation

The controller determines the power of the burner with which the boiler will work at the moment, depending of the boiler temperature setpoint and predefined hysteresis in the parameters 50% H2 hysteresis and 30% H1 hysteresis.

You can configure the H1 and H2 values so that the modulation will occur without the transient condition, i.e. passing directly from 100 % to 30 % with the omission of 50 %.

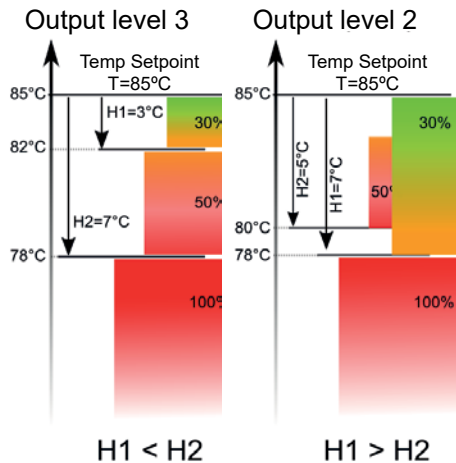

Operation in Fuzzy Logic Mode

In Fuzzy Logic mode, the controller decides automatically the burner output, at which the boiler will operate in order to maintain the boiler temperature at the preset level. The controller uses the predefined output levels same as in the Standard mode. There is no need to set parameters for H2 Hysteresis and H1 Hysteresis in this mode. The controller goes into the SUPERVISION or BURNING OFF mode when the boiler temperature setpoint is exceeded by 5 degrees.

IMPORTANT
 If only the HUW tank is heated (in the summer), we recommend to switch the controller to the Standard mode.

Supervision

In the SUPERVISION mode, the air blower operates in continuous mode and feeder operate in cycles in longer intervals than in the OPERATION mode. This is to prevent dampening the fire.

The SUPERVISION mode parameters can be accessed in the menu:

Service Settings → Boiler Settings → Supervision

Set the Supervision mode parameters so as to prevent the furnace extinguishing during the boiler outages.

IMPORTANT
 Parameters in the Monitoring mode must be selected so that the temperature decreases gradually or is maintained at a constant level. Incorrect settings can lead to overheating the boiler.

After the lapse of the monitoring time, the controller enters into the BURNING OFF mode, unless the boiler temperature has dropped earlier, and the boiler returns into the OPERATION mode automatically.

IMPORTANT
 If the monitoring time parameter = 0, the controller goes into the BURNING OFF mode immediately omitting the SUPERVISION mode.

IMPORTANT
 If the monitoring time parameter = 60, the controller remains in the SUPERVISION mode for 60min., after that time the controller goes into the BURNING OFF mode.

Burning off

In the burning off process, the remaining pellet is fired up and the boiler is prepared for stopping or switching off. All parameters affecting the burning off process are grouped in the menu:

Service Settings → Boiler settings → Burning off

The regulator stops feeding fuel and performs scavange to burn off remaining fuel. After SWITCHING OFF, the controller switches to STOP mode.

Stop

In the STOP mode, the boiler is extinguished and waits for the signal to begin operation.

The signal to begin operation can be as follows:

- the boiler temperature setpoint drops below the temperature setpoint minus the boiler hysteresis (Boiler hysteresis),
- when the boiler is configured for operation with the buffer, drop of the buffer overall temperature below the setpoint (Temperature of the buffer filling start)

CHIMNEY SWEEP mode

The regulator has a special chimney sweep mode, during which the boiler works at a constant power of 30% or 100%. The boiler works with the given power for the set time: Worktime,

This parameter can be found in the menu:

Chimney sweep mode

The function can be used to adjust the air setpoints using an exhaust gas analyzer.

Menu główne - Użytkownika

| | |
|------|-------------------------|
| MENU | Information |
| | Boiler settings |
| | HUW settings* |
| | SUMMER mode |
| | Mixer 1-5 settings* |
| | General settings |
| | Manual control |
| | Chimney-sweep |
| | Alarms |
| | Turn off the controller |
| | Service Settings |

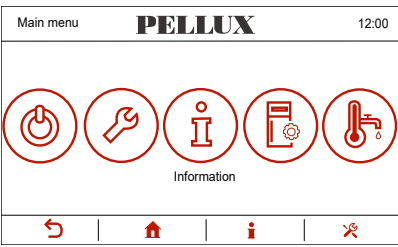
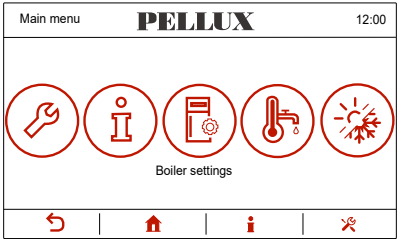
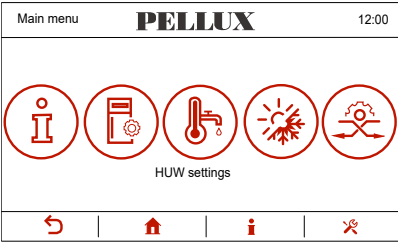
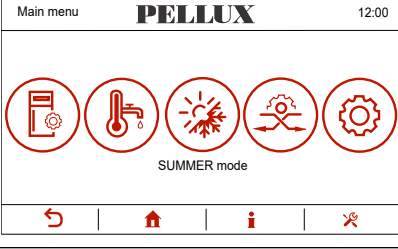
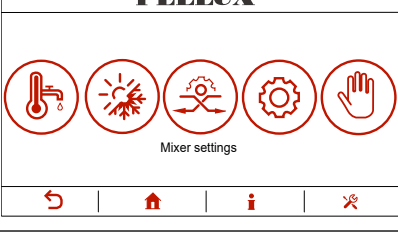
| Menu | Description |
|---|---|
|  | <p>Contains various information relating to the controller operation: measured temperatures of the buffer, boiler and mixers, input and output statuses and soft ware versions, etc.</p> |
|  | <p>Contains setpoints of the boiler-related parameters.</p> |
|  | <p>Contains settings of hot utility water-related parameters. *</p> |
|  | <p>The SUMMER mode means switching the central heating system OFF and leaving only hot utility water heating ON. Auto activation of this mode is based upon the indications of the outdoor temperature sensor.</p> |
|  | <p>This menu contains setpoints of the controlled heating circuits. These circuits are controlled by electric actuator operating the mixing valve. Lower temperature in relation to the boiler temperature can be achieved in these circuits. *</p> |

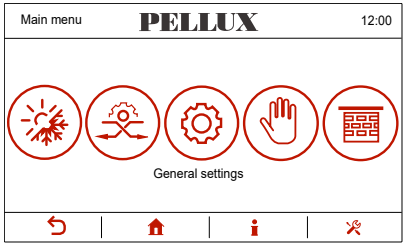
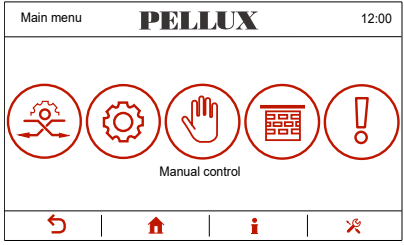
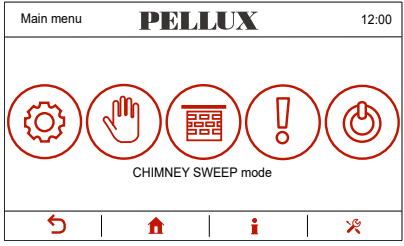
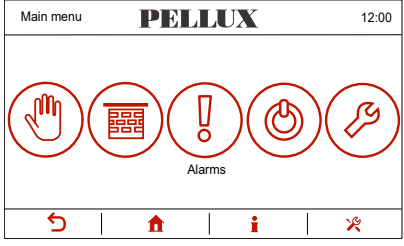
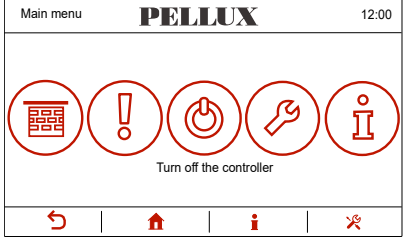
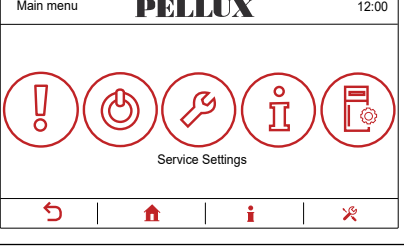
| Menu | Description |
|---|---|
|  | <p>This menu contains parameters for such settings as language, screen brightness, date, sound and soft ware updating.</p> |
|  | <p>Allows manual activation of such outputs as air blower, feeder and circulating pump. The menu is only accessible when the controller is switched OFF.</p> |
|  | <p>The chimney sweeper function allows the boiler to be started at a constant power of 30% or 100%. The boiler works with the given power for a set time: Worktime.</p> |
|  | <p>The menu contains information on alarms that occurred during the boiler operation. The alarm history may only be cleared by authorized personnel.</p> |
|  | <p>This feature allows switching the controller OFF/ON.</p> |
|  | <p>Only authorized persons should use the service settings.</p> |

* -unavailable if the appropriate sensor or additional module is not connected or the parameter is hidden.

6 Heating

General

The indoor temperature is dependent on several factors.

- The sun rays and heat emitted by humans and domestic appliances are sufficient to maintain the proper temperature in the house for a warmer part of the year.
- When it becomes colder outside, the heating system should be activated. The lower the outdoor temperature the higher the temperature of radiators (if an outside temperature sensor and mixing valve are installed.)

After entering the operating parameters of the system from the control panel, the boiler starts automatic operation providing optimal and comfortable conditions of use.

Basic Modes of Operation of the Boiler

Controlling of heat production is based on the readout of indications of two temperature sensors installed outdoors and indoors (for the room temp). The control consists in adjusting the temperature of the fluid flowing in the heating circuit. Adjustment takes place by operation of the mixing valve actuator and readout of the temperature from the sensor on the pipe downstream the valve.

Outdoor Temperature Sensor

The boiler heats up the heating medium to the desired temperature in manual mode. When in auto mode, the heating medium temperature is set basing on information obtained from the outdoor sensor and sensors installed in the lines supplying radiators (sensors downstream the mixer, one per each circuit.)

The temperature sensor (installed on the outside wall of the building, from the north) detects the temperature variations, which makes that the boiler is able to respond automatically to the outdoor temperature drops before the rooms in the house cool down. Adjustment of the heating medium temperature is implemented by the mixing valves.

Room Temperature Sensor – Installed in ecoSTER TOUCH (Option), eSTER_x80, eSTER_40

This sensor measures the temperature in the room and balances the heating medium temperature on the heating circuit supply. If the temperature exceeds or falls below the setpoint, the flow temperature is reduced or increased by the mixing valve accordingly.

Manual Control of the Boiler Working Temperature (System Without Mixing Valve)

The user can set the boiler to operate at a preset temperature, which translates directly to the temperature of radiators. The controller can increase the boiler temperature setpoint automatically to allow filling of the HUW tank or supply the heating circuits of the mixers.

Mixer Settings (Without the Weather Sensor)

Set the required water temperature in the mixer heating circuit manually by means of the Preset mixer temperature parameter, e.g. to 50°C. This value should be selected so, as to ensure achieving the required room temperature.

After connecting the room thermostat, set the value of the mixer temperature setpoint decrease by the Mixer room therm. e.g. to 5°C. Select this value experimentally. A regular thermostat (of NO/NC type), eSTER_x40 or the ecoSTER TOUCH, eSTER_x80 room panel can serve as the room thermostat. After activation of the thermostat, the mixer temperature setpoint will decrease, which, at the correctly selected value of the decrease, will prevent the temperature increase in the room heated.

Settings of the Mixer with the Weather Sensor (Without room panels)

Set the Mixer with the Weather Sensor parameter to ON.

Select the weather curve.

With the Parallel Shift of the Curve parameter, set the room temperature setpoint using the following formula: Room Temp Setpoint = 20°C + Parallel Shift of the Heating Curve.

Example:

In order to achieve the room temp of 25°C, the heating curve parallel shift value has to be set to 5°C. In order to achieve the room temp of 18°C, the heating curve parallel shift value has to be set to -2°C. At such a configuration, you can connect the room thermostat that will eliminate any inaccuracy in the selection of the heating curve in a situation when the heating curve value selected is too high. In such a situation, select the decrease value for the mixer temperature setpoint controlled by the thermostat to e.g. 2°C. The mixer circuit temperature setpoint will decrease when the thermostat contacts open, which, at correctly selected the decrease value, will prevent the temperature increase in the room heated.

Settings of the Mixer with the Weather Sensor and room panels

Set the Mixer with the Weather Sensor parameter to ON. Select the weather curve depending on the heat demand basing on the diagram below.

The ecoSTER TOUCH thermostat shifts the heating curve automatically, depending on the room temperature setpoint. The controller refers the setpoint to 20 °C, e.g. for the room temp setpoint = 22°C, the controller will shift the heating curve by 2°C, and for the room temperature setpoint = 18°C, it will shift the heating curve by -2°C. In some situations, the heating curve shift may require additional adjustments.

In this configuration, the ecoSTER TOUCH room thermostat can :

- decrease the heating circuit temperature by a constant value, after reaching the room temperature setpoint, similar to the description above (not recommended), or
- adjust the heating circuit temperature continuously, in auto mode.

Use of these two options at the same time is not recommended. Automatic adjustment of the room temperature occurs in accordance with the following formula: Adjustment = (Room Temp Setpoint – Room Temp Measured) x Room Temp Coefficient /10.

Example:

Temperature setpoint in the room heated (set in ecoSTER TOUCH) = 22 °C. The temperature measured in the room (by ecoSTER TOUCH) = 20 °C. Room temp coefficient = 15. The mixer temperature setpoint will be increased by $(22^{\circ}\text{C} - 20^{\circ}\text{C}) \times 15/10 = 3^{\circ}\text{C}$. Find a correct value of the Room Temp Coeff. parameter. Range: 0...100. The higher value of the coefficient, the higher adjustment of the boiler temperature setpoint. When this parameter is set to 0, the mixer temperature setpoint is not adjusted. Note: If you select too high value for the room temp coefficient, this may result in cyclic variations of the room temperature!



CAUTION

If you select too high value for the room temp coefficient, this may result in cyclic variations of the room temperature!

Weather-Based Control

Depending on the measured outdoor temperature, both the boiler temperature setpoint and the mixer circuit temperatures can be controlled in auto mode. If the heating curve is selected correctly, the heating circuit temperatures are calculated automatically depending on the outdoor temperature. Due to this, if the heating curve selected for a specific building is correct, the room temperature remains approximately constant, regardless of the temperature outdoors by setting the parameter.



CAUTION

In the process of experimental selection of the heating curve, temporarily exclude the influence of the room thermostat on the operation of the controller (regardless of whether the room thermostat is connected or not) by setting the parameter for mixing circuit:

Mixer settings → **Mixer room therm.=0**

If the ecoSTER TOUCH room panel is connected, set the Mixer room therm. parameter temporarily to 0.

Guidelines for the correct selection of the heating curve :

- floor heating 0,2 -0,6
- radiators 1,0 - 1,6
- boiler 1,8 - 4

Heating curves

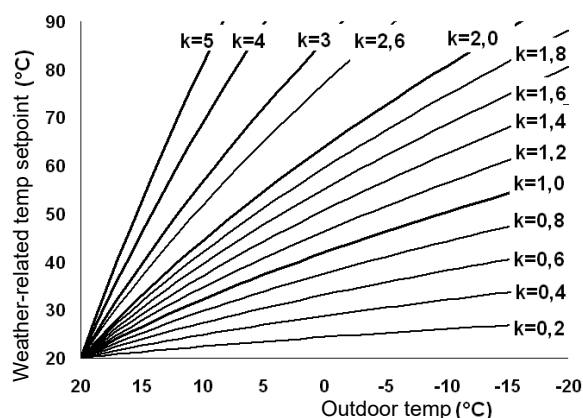

Guidelines for the selection of the correct heating curve:

- if the room temperature increases when the outdoor temperature decreases, the heating curve value selected is too high
- if the room temperature decreases when the outdoor temperature also decreases, the heating curve value selected is too low
- if during the cold weather (frost), the room temperature is correct, but it is too low after warming outdoors, increase the Parallel Shift of the Heating Curve parameter and select a lower heating curve
- if during the cold weather (frost), the room temperature is too low, and it is too high after warming outdoors, increase the Parallel Shift of the Heating Curve parameter and select a higher heating curve.

Poorly insulated buildings require selection of higher heating curves, while in well insulated buildings, the heating curve will be of lower value.

The temperature setpoint calculated acc. to the heating curve may be decreased or increased by the controller, when it falls outside the temperature limits for a specific circuit.

Night Decrease Settings

The controller has the option of setting time intervals for the boiler, heating circuits, HUW tank and HUW circulation pump. Intervals allow decreasing the temperature setpoint for a specific interval, e.g. at night or when the user leaves the room heated (e.g. going out to work/school, etc.) Due to this, the temperature setpoint can be decreased in auto mode without losing the thermal comfort, while decreasing the fuel consumption. In order to activate the intervals, set the Night Decrease parameter for a specific heating circuit to ON. The "Decrease" parameter sets the setback temperature, one for all time intervals. Night time decreases can be defined separately for all days of the week in the "Schedule" setting.

The button  allows you to copy the current schedule definition to any days of the week.

Use the button  to select the decrease in the set temperature for the given time period. Time periods for the day are set every 30 minutes.

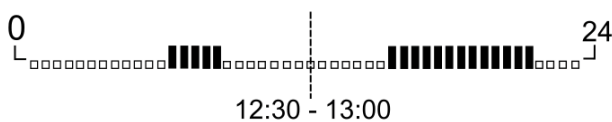

Above is an example of a night decrease in the preset temperature of the hot utility water tank lasting from 22:00 to 06:00 and a decrease from 09:00 to 15:00.

 **CAUTION**
Intervals are omitted when their decreases are set to 0, even when some time limits have been preset.

Selecting the heat source for the mixer

When working with a buffer, it is possible to select the HEAT SOURCE for the heating circuit of the mixer, depending on the connection point of the given circuit to the heating installation. After activating the BUFFER menu (connected sensors: top buffer, buffer down), the following menu appears:

Service settings → Mixer settings → Heat source

By choosing BUFFER, the CH pump mixer will start after reaching the parameter:

Service → Buffer settings → Start heating installation

When selecting the BOILER, the CH pump mixer will start after reaching the parameter:

Service → CH and HUW settings → Pump Temp. start

Return protection 3-way

The function allows you to protect the return temperature using a three-way mixing valve with an actuator. The mixer 1 sensor serves as a return temperature sensor Tp. The actuator should be connected in place of the mixer 1 actuator.

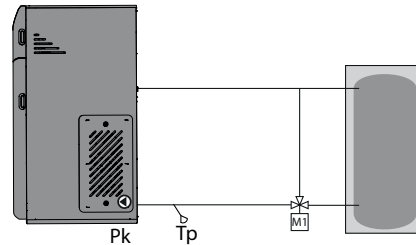

Tp – mixer sensor 1 M1 – mixer 1
Pk – boiler pump

Return protection 4-way

The function allows you to protect the return temperature. In a situation where the temperature of water returning to the boiler Tp is lower than specified in the 'Temp. return protection', are closed: Mixer 1 to the value 'mixer stoppage'. The upper buffer sensor serves as the return temperature sensor Tp. Temp. return is a priority in relation to the temperature of Mixer 1. When 4-way return protection and buffer handling are enabled, 4-way protection is inactive.

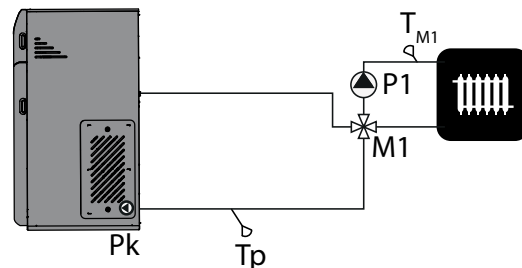

Tp – upper buffer sensor P1 – pump mixer 1
PK – boiler pump TM1 – mixer sensor 1
M1 – mixer 1

 **CAUTION**
These are pictorial diagrams showing only the principle of return protection operation, and therefore they do not contain all elements of the installation. Appropriate diagrams should be made by an authorized person, in accordance with applicable regulations.

7 Hot Utility Water

Hot Utility Water (HUW) Settings

The unit controls the temperature of the hot utility water (HUW) tank, if the HUW temperature sensor is connected, by means of the parameter:

HUW Settings → HUW Pump Mode

The user can:

- activate the tank filling; the parameter is set to OFF
- set the HUW priority with the Priority parameter; then, the CH pump is switched OFF in order to fill the HUW tank faster
- set the parallel operation of the CH and HUW pumps; the parameter is set to No Priority.

HUW tank disinfection

The controller includes the feature for automatic, periodic heating of the HUW tank up to 70°C in order to eradicate bacterial flora from the HUW tank. The function is activated in the menu:

HUW Settings → HUW disinfection



CAUTION

You must inform household members about the fact of enabling the disinfection feature, as there is a danger of scalding with hot water.



CAUTION

You can use a mixing valve with fixed or adjustable setpoint in the hot water intake pipeline as an additional protection against scalding.

The controller increases the HUW tank temperature once a week, in the night from Sun to Mon at 02:00 am. The HUW pump is switched OFF and the boiler returns to normal operation after maintaining the tank temperature of 70 °C for 10 min. Do not enable the disinfection feature when the HUW operation feature is deactivated.

Setting of the HUW Temperature Setpoint

The HUW temperature setpoint is specified by the parameter :

HUW Settings →HUW preset temperature

The HUW tank hysteresis

Below the temperature: HUW preset temperature – HUW Tank Hysteresis the HUW pump starts in order to fill the HUW tank.



CAUTION

If you set a small hysteresis value, the HUW pump starts within shorter time after the HUW temperature drop.

HUW Circulation

The settings can be accessed at:

Boiler Settings →Schedule of circul. pomp

Settings for time control of the circulation pump are analogous to the night time decrease settings. At defined intervals, the circulation pump is off, in omitted intervals, the circulation pump is switched on for "Circulation pump operation time", which is "Circulation pump standstill time". Parameters are in the menu:

Service settings → CH and HUW settings

Activation of the summer feature

In order to activate the SUMMER feature enabling filling the HUW tank in the summer without heating the entire central heating system, set the Summer Mode to Summer.

MENU → SUMMER mode

Switching between the Summer and Winter modes may be automatic, if the weather sensor is installed.



CAUTION

All heat consumers may be deactivated in the Summer mode. Therefore ensure that the boiler will not overheat before activating this mode.

8 Other Boiler Settings

Fuel Level Configuration

In order to activate the fuel level display, set the parameter

Boiler Settings → Fuel Level → Alarm Level

to a value higher than zero, e.g. 10%.

You can select the fuel level indicator by touching on the LH or RH window in the Home screen.

Tip: the fuel level can also be visible in the ecoSTER TOUCH room panel.

 **ADVICE**
The room panel is not included in standard version of the controller.

Operation of the fuel level indicator

Push and hold the current value of the fuel level after each filling of the fuel tank. The following prompt will appear:

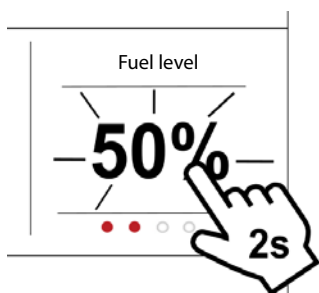

Set the Fuel Level to 100% . After selecting and accepting with YES, the fuel level will be set to 100 %.

 **CAUTION**
You can refill the fuel at any moment, without waiting until the fuel dispenser will be empty. However, always refill the fuel up to the dispenser level corresponding to 100% in the controller as described above.

Operation

The controller calculates the fuel level basing on its current consumption. The factory settings not always will correspond to the actual fuel consumption by a specific boiler. Therefore, this method requires calibration of the fuel level by the controller user in order to operate correctly. No other fuel level sensors are required.

Calibration

Fill the fuel dispenser to the level corresponding to 100% load and set the parameter:

Boiler Settings → Fuel Level → Fuel Level Calibration → Fuel Level 100 %

The fuel level indicator in the Home panel will be set to 100%. A sign of the calibration process is the pulsing level indicator fuel. The indicator will blink until the point corresponding to the minimum fuel level. Check the decreasing fuel level in the dispenser on an ongoing basis. When the fuel level drops down to the minimum expected, set the value of the parameter:

Boiler Settings → Fuel Level → Fuel Level Calibration → Fuel Level 0%

Information

Menu Information allows preview of the measured temperatures and checking, which units are currently operating.

 **CAUTION**
Information on additional mixer are displayed after the connection of the extension B module.

Manual Control

The controller enables manual activation of executive devices, such as a pump, feeder motor or fan, where on the screen OFF means that the device is turned off, and ON means that the device is turned on. This makes it possible to check whether the given devices are operational and properly connected.

 **CAUTION**
Entering the manual control menu is possible only when the boiler is turned off.

 **IMPORTANT**
Operation of the air blower or other unit for a prolonged period of time may lead to danger.

Cooperation with the room panel

The regulator can cooperate with:

- eSTER_x40 wireless battery room thermostat and eSTER_x80 wireless room panel,
- ecoSTER TOUCH wired room panel.

The thermostat and room panel simultaneously provides useful information, among others: information about the fuel level, burner operation status, signals alarms, allows you to set the controller parameters, its modes of operation, also serves as an additional boiler control panel.

Cooperation with the internet module

The controller can cooperate with the ecoNET300 internet module. It enables viewing and controlling the

controller online via WiFi or LAN via the website www.econet24.com via a web browser or a convenient application for mobile devices.

9 Maintenance and Troubleshooting

General

Alarm

If an active alarm exists, a message ALARM appears in the top left corner of the controller. Then, information on the alarm appears in the Home panel.

In order to check the alarm, enter the Home menu, to ALARMS, where the alarm description is displayed as well as the date of its occurrence.

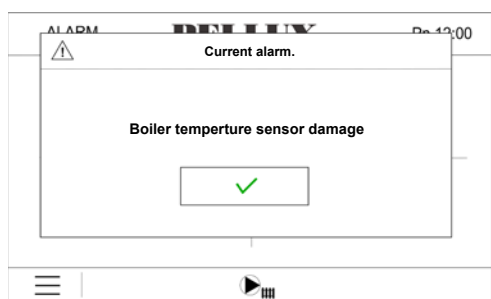

Exceeding Max Boiler Temperature

The boiler protection against overheating has two stages. First, i.e. after exceeding the boiler cooling temperature, the controller tries to decrease the temperature by discharging the heat excess to the HUW tank and by opening the mixer actuators (only if the mixer operation is set to CH ON). If the temperature measured by the HUW sensor exceeds the Max HUW Temp, the HUW pump is switched OFF in order to protect the users against scalding. When the boiler temperature drops down, the controller returns to normal operation. Otherwise, if the temperature continues to increase (and reaches 95°C), a permanent boiler overheating alarm will be launched together with sound alarm. The alarm can be cleared by pressing the temperature limiter and confirming the alarm.

Boiler Temperature Sensor Damaged

This alarm occurs when the boiler temperature sensor becomes damaged and when the measuring range of this sensor is exceeded. Check the sensor and replace it, if required.

Firing Up Attempt Failed

This alarm occurs after the third attempt to fire up the furnace in auto mode. Causes of this alarm can be e.g. the following: failed igniter or damage to the fuel supply system, inadequately selected parameters, poor fuel quality, no fuel in the dispenser, etc. The alarm can be cleared after acknowledgment or by switching the power supply off and on.

IMPORTANT

Check, whether no excess of the non-fired fuel has been accumulated in the furnace before continuing operation. If so, remove any fuel excess. Firing up with the fuel excess may result in explosion of flammable gases!

No Communication

The control panel is connected to the remaining electronic circuits via RS485 digital communications link. If the cable of this link becomes damaged, the following alarm will be displayed on the panel Caution! No Communication. The controller does not switch the control OFF and operates at normally preset parameters. Check the cable connecting the control panel with the module, and replace or repair it.

Burner

Inspection and regulation should be carried out before each heating season by a specialist in this field.

Soot and Ash Removal

Clean the chimney regularly at the intervals described in the relevant fire regulations. The frequency of cleaning of the boiler depends on the mode of its operation and requires monitoring.

The boiler is equipped with a mechanical system for removing soot from the flues (smoke tubes). Cleaning must be carried out each time the ash container is emptied.

When emptying the ash container, also clean the service compartment under the burner. The exhaust fan, burner and air chamber should be cleaned at least once a month.

Cleaning the mounting surfaces of the turbulators and the flue gas chamber should be performed at least twice a year.

Performing these activities is the responsibility of the boiler user and is not part of the warranty.

For more information, see Cleaning on page 48.

**CAUTION**

Always disconnect the power supply when performing servicing or maintenance of the boiler and burner.

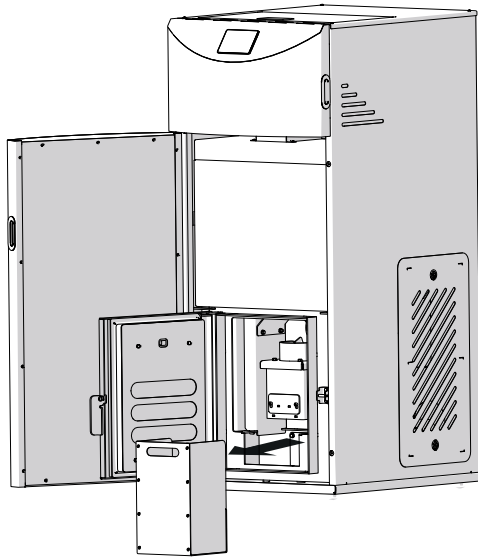

The ash container is located under the combustion chamber. It should be emptied at least once a week, depending on the amount of fuel burned. To remove it, lift the container up and, tilting it towards you, pull it out of the boiler.

**CAUTION**

After opening the boiler door during operation, after approx. 1 min. the alarm of exceeding the minimum negative pressure in the chamber will be signaled. The boiler will go into the burn off mode.

**CAUTION**

You can only begin cleaning after damping a fire and after the furnace temperature drops down to the ambient temp. Use the adequate personal protective equipment when cleaning.

Causes of Failure and Remedy

In the event of malfunction or failure, please check the following items.

**CAUTION**

Boiler must be filled with the heating medium during start-up!

Low room temperatures

- Incorrectly set (connected) mixing valve.
- STB temperature limiter is ON. It could be switched ON during handling.
- Unvented boiler or radiators.
- Shut-off valve in the heating system closed
- Circulating pump switched OFF or jammed.
- Burner failure
- Overcurrent circuit breaker tripped
- Max temperature of the heating medium in the boiler shell is too low
- Boiler is not switched ON
- Burner could be switched OFF by an external controller

**CAUTION**

It takes some time to note the temperature change in a room. Short intervals between any setting changes together with floor heating do not provide any noticeable difference in the room temperature.

High Room Temperatures

- Heating automation settings incorrect
- Mixing valve stuck in open position
- CH sensor installed incorrectly
- Faulty controller settings

Resetting of temperature limiters in the feeder and boiler (STB)

The device is equipped with two temperature limiters. Both limiters are located behind the right inspection cover of the boiler.

The temperature limiter in the feeder (not to be confused with the STB in the boiler), when the temperature of 90°C is reached, cuts the power supply to the feeder and the blower fan and activates the alarm. The limiter resets itself when the temperature drops.

The boiler temperature limiter (STB) cuts the feeder and fan power supply and activates the alarm when the temperature near the limiter is 95°C.

The boiler temperature limiter must be turned on manually.

More information in the section Boiler and feeder temperature limiter on page 47.

Low temperature of the hot utility water

- Abnormally large hot water usage
- Wrong setpoint of the mixing valve
- Shut-off valves at the heat exchanger throttled or fully closed
- Boiler's temperature limiter has tripped, this can occur during transportation
- Circulating pump set to lower speed or switched OFF
- Too large flow of the hot utility water

- Burner failure
- Burner could be switched OFF by an external controller
- Circuit breaker tripped
- Boiler is switched OFF
- Incorrect parameters set in the controller settings

- Shut-off valve in the cold water supply line to the heat exchanger throttled or closed
- Too low hot water temp setpoint



IMPORTANT

Tripping of the STB temperature limiter is a warning. If the situation repeats, call the installer.

10 General Information for Installers

Location of the Boiler

The boiler should be installed in accordance with local regulations. Installation of the boiler and pellet feeder on an even and levelled concrete foundation with a height of at least 5 cm and the edges protected by steel kerbs is recommended.

The boiler room should have adequate air exchange. There should be properly designed and made supply ducts and an exhaust duct.

Ventilation ducts shall be made of non-combustible materials. Adequate lighting, as far as possible covered by natural light, should be ensured, but also the artificial lighting installation should be provided.

The use of other combustion fuels in the burner is prohibited.

Pellets must be stored in a dry and clean place.



ADVICE

It is recommended to use high quality fuel, coming from reliable sources. Fuel should have adequate moisture and not contain mechanical impurities (e.g. sand, stones, metal chips, etc.), which may deteriorate the combustion process and cause failure of the unit.



CAUTION

NIBE-BIAWAR shall not be liable for any malfunction and improper combustion resulting from the use of improper fuel.

Chimney – Requirements



CAUTION

Ensure that the chimney cleaning is carried out in accordance with the procedures in force. If doubt, please contact a chimney sweep.

A chimney with appropriate draft and dimensions is the basic condition for the proper functioning of the heating boiler. The efficiency and economy of work largely depend on it. The boiler can only be connected to a chimney with the appropriate draft (technical specification page 57). It is important that the diameter (cross-section) and height of the flue pipe are such that too high pressure cannot build up in the boiler and in the flue pipe.

The Pellux Slim boiler has a round flue gas outlet with a diameter of 80. The outlet should be tightly connected (eg with a connection made of appropriately thick sheet metal) to the chimney. The connection should be above the chimney hatch.



CAUTION

Before installing, the flue pipe has to be tested and approved by a chimney sweep.

Pellet – Requirements

The PBMAX burners installed in the boiler are designed to fire the high quality wood pellets size 6 ÷ 8 mm, maximum length of 30mm and maximum moisture of 12 %, calorific value > 17 MJ / kg, ash content ≤ 0.5% according to EN 14961-2.

Distance to Walls

Set the boiler while maintaining the minimum distances to the walls. When installing the unit, pay special attention to a convenient access to the boiler, burner and chimney during maintenance, cleaning and servicing.

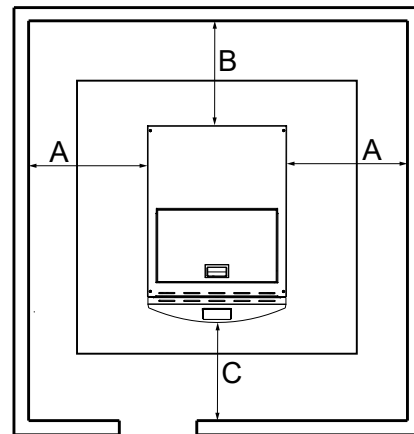

Minimum distances to the building walls Pellux Slim

| Dimension | Distance [m] |
|-----------|--------------|
| A | 0,8 |
| B | 0,6 |
| C | 1,5 |

**CAUTION**

There is a risk of carbon monoxide poisoning when the boiler located in an under-ventilated area.

Installation

Comply with the applicable laws when installing the boiler.

The heating system and the boiler-room shall be made in accordance with local regulations.

The heating system of the closed layout shall meet the requirements of local regulations and shall be fitted with the system safety devices, such as:

- safety valve with the inlet and outlet pipe
- diaphragm expansion vessel
- expansion pipe
- protection of the heat source against exceeding the allowable temperature of the system water
- accessories: measuring and control devices, indicating at least the temperature of the system water inflow and pressure in the system; fittings for automatic venting of the expansion pipe; blowdown fittings that allow draining of the expansion vessel water tank.

If the system has the open expansion vessel installed, then, the difference in height between the highest positioned radiator and the expansion vessel shall not be less than 2.5 m.

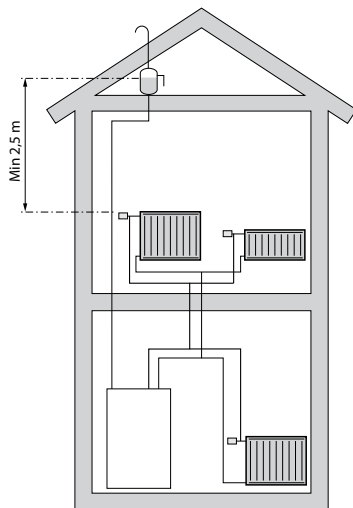
**CAUTION**

Before connecting the boiler, flush the system to remove small debris that can damage the boiler or pump.

Disassembly and disposal of the device when finished its operation

After decommissioning, make sure that the product and all equipment are disposed of in accordance with applicable regulations.

11 Connection to the System

The diagrams below show the connection of the PELLUX boiler with a hot utility water exchanger, in an open system with heating circuit and a domestic hot water circuit.

Pellux Slim connected to a heating circuit with a four-way valve and a DHW exchanger.

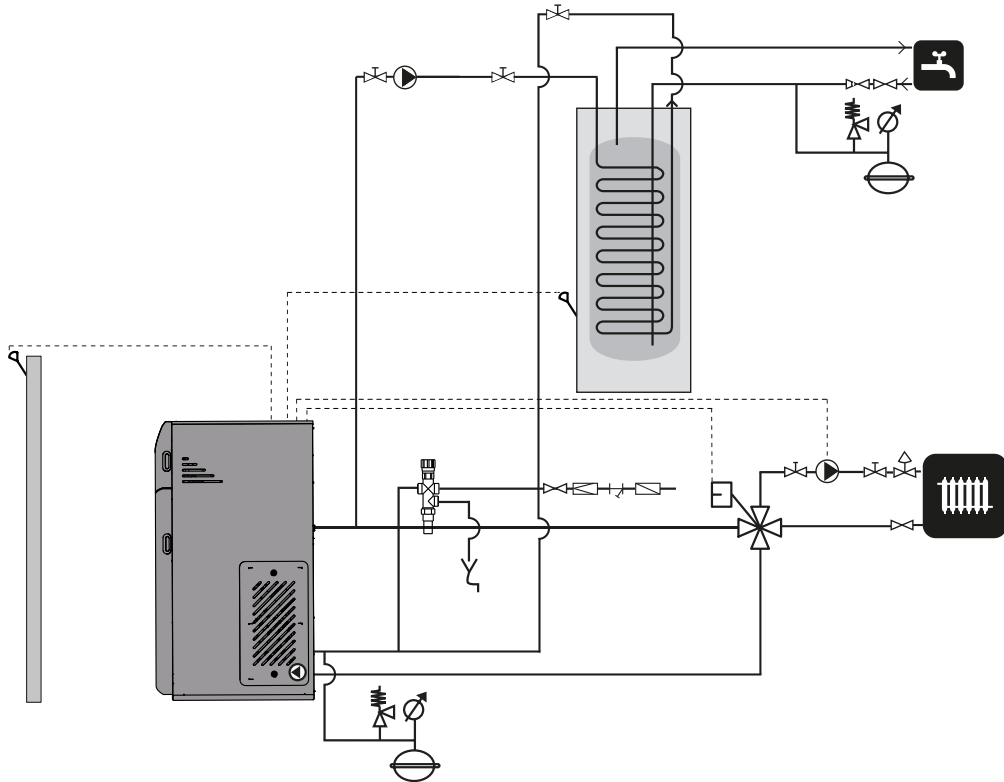

Pellux Slim open system with adjustable heating circuits and DHW circuit

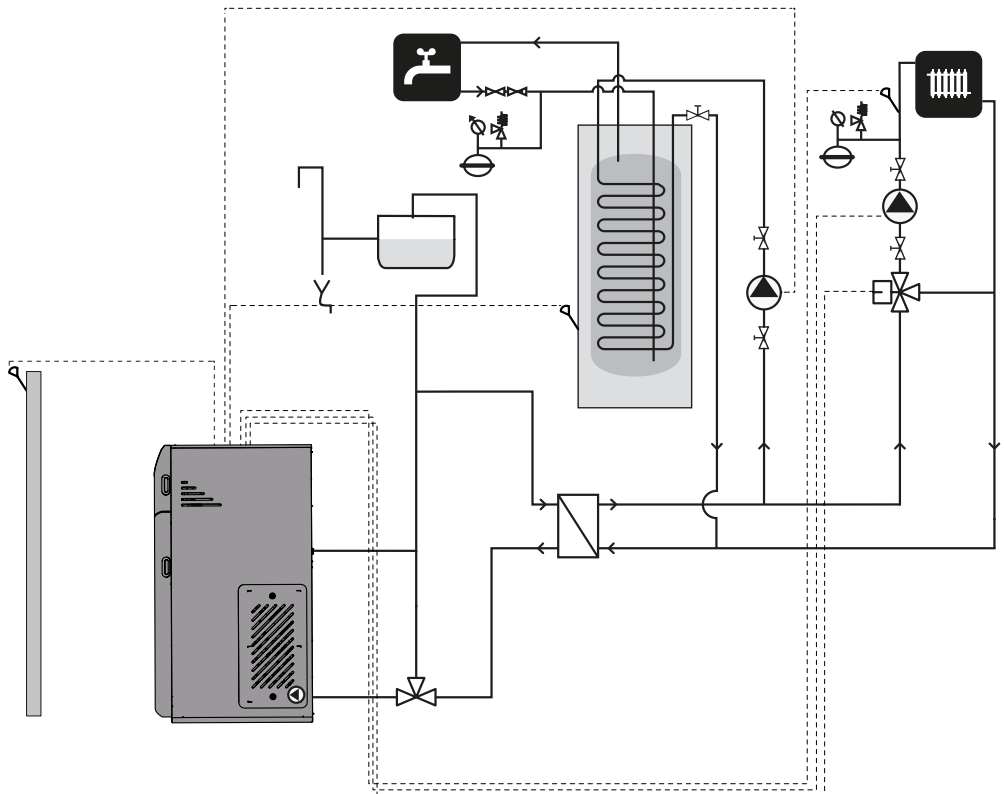

CAUTION

These are schematic representations only. The actual diagrams of the system should be developed by an individual qualified to do so, in compliance with all standards and regulations.

12 Electrical connections

Direct Connection of the Units



CAUTION

Never connect the protective conductor (PE) to the neutral conductor (N).

The diagram below shows connection of the CPU and ecoDRIVE module to the control panel and accessories that do not require any additional modules.

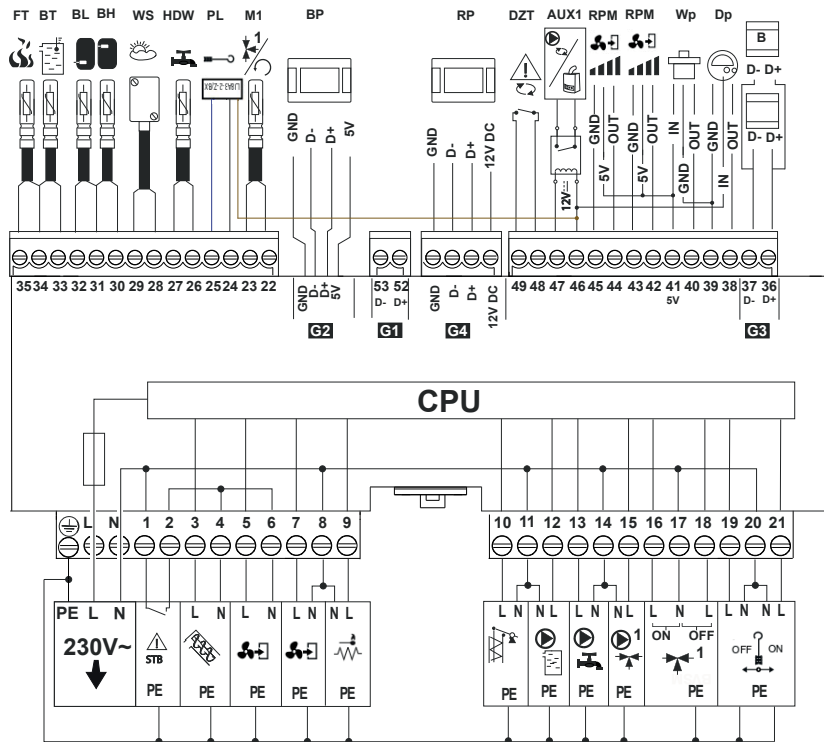

The diagram below shows connection of the additional B module.

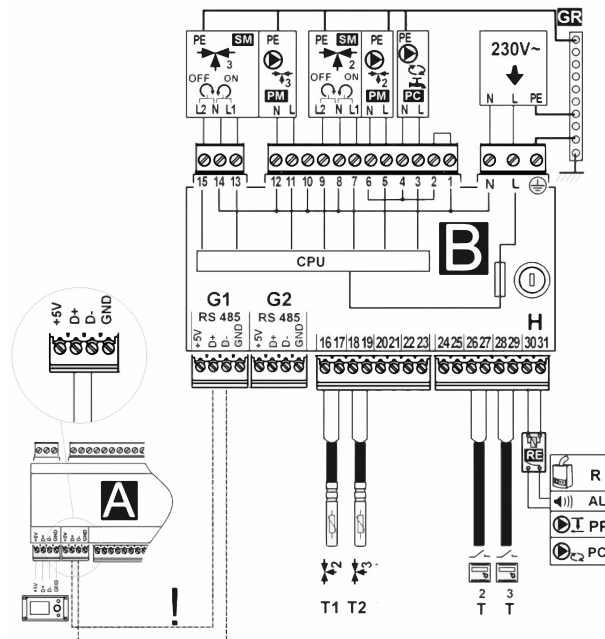

| Exits: | Description |
|--------|---|
| 1-2 | STB - boiler safety temperature limiter |
| 3-4 | fuel feeder |
| 5-6 | air blower |
| 7-8 | exhaust fan |
| 8-9 | igniter |
| 10-11 | cleaning the exchanger |
| 11-12 | boiler pump |
| 13-14 | hot utility water pump |
| 14-15 | mixing valve pump |
| 16-17 | mixing valve actuator ON |
| 17-18 | mixing valve actuator OFF |
| 19-20 | grate cleaning ON |
| 20-21 | grate cleaning OFF |

| Designation | Description |
|-------------|--|
| DZT | Burner temperature sensor |
| L N PE | 230VAC mains |
| STB | safety temperature limiter IN |
| BT | CT4 boiler temp sensor |
| HDW | CT4 hot utility water temp sensor |
| BH | buffer temp sensor, upper |
| BL | buffer temp sensor, lower |
| M1 | CT4 controlled circuit temp sensor (mixing valve #1) |
| WS | CT6-P temp sensor, weather sensor |
| FT | CT2S flue gas temp sensor |
| BP | control panel |
| RP | ecoSTER TOUCH room panel w. room thermostat feature |
| RPM | controlled output for the fan |
| CPU | control |
| DP | Vacuum sensor |
| WP | Water pressure sensor |
| PL | grate cleaning contact |
| AUX1 | |
| B | transmission connector with expansion modules |

Electrical Connections

The controller is adapted to 230VAC, 50Hz. The electrical installation should be:

- 3-conductor (with protective conductor),
- compliant with applicable regulations,
- equipped with a residual current circuit breaker with a tripping current $I_{\Delta n} \leq 30\text{mA}$ protecting against the effects of electric shock and limiting damage to the device, including fire protection.

CAUTION

Dangerous voltage can be present on the controller contacts after switching the controller OFF from the panel. Always disconnect mains before beginning any installation work and ensure that no dangerous voltage is present on the terminals and conductors.

Connecting cables may not contact any surfaces, temperature of which exceeds their nominal operating temperatures. Terminals No. 1-21 are designed for the connection of 230VAC devices and terminals No. 22-49 are for low voltage equipment (up to 12VDC.)

CAUTION

Connection of 230VAC to the terminals No. 22-49 and transmission connectors No. G1-G4 results in the controller damage and poses a risk of electric shock.

Ends of the cables connected, particularly of the mains cables, must be protected against delamination by, e.g. insulated crimp sleeves. Connect the power cable to the terminals marked with an arrow, N,L,PE →230V~.

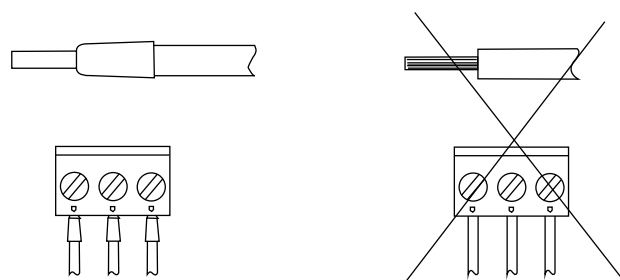

CAUTION

For safety reasons, the regulator must be absolutely connected to the 230V ~ power network in the order of phase (L) and neutral (N) connection. Make sure that the L and N conductors have not been swapped within the building's electrical system, e.g. in an electrical socket or distribution box!

CAUTION

Connection of any peripheral devices may only be carried out by a qualified person in accordance with applicable regulations. Examples of such devices are pumps, servomotors or a relay marked as "RELAY" and receivers connected to it. It is important to remember the safety rules related to electric shock. The regulator must be equipped with a set of plugs inserted into connectors for supplying devices with 230V ~ voltage.

Connect the power cable protective conductor to the zero terminal strip. Connect the zero terminal strip to the controller terminals marked with the ⊕ symbol and to the protective conductor terminals of the equipment connected to the controller

Connection

The boiler is equipped with a controller that controls operation of the burner, circulating pumps, actuators and other equipment. Electrical connection of external devices shall be made by an appropriately authorized and qualified electrician. Outputs supplying external devices shall be connected in accordance with the relevant indications.

- Power supply: 1/N/PE 230 VAC 50 Hz
- Outputs to external devices: 230 VAC/50Hz

For the detailed wiring diagram, see **chapter Wiring Diagrams**.



CAUTION

Only an appropriately authorized and qualified electrician may connect the electrical installation and perform its servicing. The electrical installation and cable routing must be done in accordance with applicable regulations.

Internal Overvoltage Protection

Automatic controller of the heating system, pump, burner, actuator and the system of supplying these devices are internally protected by a 5 A miniature circuit breaker (MCB.)

Control Panel Connection



CAUTION

Power supply of the heating system must be disconnected when connecting the control panel.

The control panel is connected to the CPU communications module and power supply in accordance with the wiring diagram.

Connect the sensors and actuators to the controller, as required for the correct boiler operation, according to the individual configuration. Some adjustments in the system may be required before the boiler start-up.

Connection of any additional accessories may require installation of additional B/C module.

Make the connections with 2x0,14mm² communications cable, allowing installation of accessories, such as:

- Up to 2 heating circuits with mixing valves
- Lambda sensor



CAUTION

Connection may only be performed with power supply disconnected and only by an individual appropriately authorized to do it.

Connection of the Outdoor Temperature Sensor

The controller works with the weather sensor type CT6-P. Install the temperature sensor on the external wall from the north, or north-west side in such a way that the morning sun does not affect the temperature readouts. It should be installed at a height of approx. 2 m above the ground and far from windows, chimneys or other heat sources (at least 1.5m) that might interfere the temperature measurements. The sensor is connected to the A module with two-wire conductor. Minimum area of the conductor is 0.5 mm², and length max 25 m. Conductor polarity is not relevant. Connect the other end of the conductors to the controller terminals. Install the sensor on the wall using the mounting screws. You can access the mounting screw holes by removing the sensor housing cover.

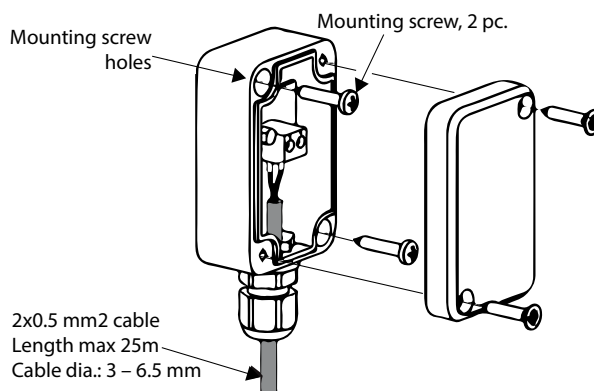

Heating Medium Temperature Sensors

Connect the sensors to the control unit and install them in the appropriate heating circuit. You can extend the sensor cables with an area of at least 0.5 mm². However, total length of cables of each sensor should not exceed 15 m. Install the hot utility water tank temperature sensor in a thermowell welded into the tank. The best location of the mixing valve temperature sensor is in a sleeve inserted into the water flowing in the pipe directly downstream the mixing valve. However, the sensor can also be fitted on the pipe, provided that the sensor and the pipe are wrapped with thermal insulation protecting them. The sensor cables should be isolated from the power cables. Otherwise, faulty temperature readouts can be obtained. Minimum distance between these cables should be at least 10cm. Avoid any contact of the sensor cables with any hot parts

of the boiler and the heating system. The temperature sensor cables are resistant up to the temperature of 100°C.



CAUTION

The sensors must be secured against loosening from the surfaces to which they are attached.

Mixing Valve Room Thermostat

Install the thermostat in a neutral location, where the temperature setpoint is to be achieved. An adequate location is e.g. an empty internal wall in a hall, approx. 1.5 above the floor. It is important that the thermostat is not installed in a niche, between shelves, behind a curtain, above a heat source or in its vicinity, in a draught from entrance doors or in direct sunlight. The thermostat sensor should freely measure the correct room temperature. A closed heater thermostat can also cause some issues with proper analysis of the demand for thermal energy produced by the boiler in a room. The room thermostat with open contacts decreases the mixing valve circuit temperature setpoint by the value of the mixing valve temperature setpoint decrease controlled by the thermostat. The parameter can be accessed at:

Mixer Settings → Mixer room therm.

Select the value of this parameter that the temperature in the room decreases after tripping (i.e. opening of contacts) of the room thermostat.

For the ecoSTER TOUCH room panel, ensure that the Thermostat Selection parameter is set correctly.

Service Settings → Mixer Settings → Thermostat Select

Boiler Room Thermostat

The rules for selecting the location of this thermostat are the same as for the mixing valve room thermostat. The room thermostat for the boiler circuit can switch OFF the burner or the CH boiler pump. In order to ensure correct switching OFF of the boiler by the thermostat, set the Thermostat Selection parameter to the general purpose or ecoSTER T1 thermostats (if the ecoSTER TOUCH room panel is connected.)

Service Settings → Boiler Settings → Thermostat Selection

In order to allow the thermostat to switch the mixer 1, 2, 3, 4 pump OFF (without switching the burner OFF), set the Pump Switch OFF by the Thermostat to YES.

Service Settings → Mixer 1 Settings → Pump Switch OFF by the Thermostat

Tables of Resistances of the Temp Sensors Used

For the mixing valve, boiler, return line, HUW and CT-4 buffer temp sensors

| Temperature (°C) | Resistance Min. (kΩ) | Resistance Nom. (kΩ) | Resistance Max. (kΩ) |
|------------------|----------------------|----------------------|----------------------|
| 0 | 802 | 815 | 828 |
| 10 | 874 | 886 | 898 |
| 20 | 950 | 961 | 972 |
| 25 | 990 | 1000 | 1010 |
| 30 | 1029 | 1040 | 1051 |
| 40 | 1108 | 1122 | 1136 |
| 50 | 1192 | 1209 | 1225 |
| 60 | 1278 | 1299 | 1319 |
| 70 | 1369 | 1392 | 1416 |
| 80 | 1462 | 1490 | 1518 |
| 90 | 1559 | 1591 | 1623 |
| 100 | 1659 | 1696 | 1733 |

For the CT2S-2 flue gas sensor

| Temperature (°C) | Resistance Min. (kΩ) | Resistance Nom. (kΩ) | Resistance Max. (kΩ) |
|------------------|----------------------|----------------------|----------------------|
| 0 | 999,7 | 1000,0 | 1000,3 |
| 25 | 1096,9 | 1097,3 | 1097,7 |
| 50 | 1193,4 | 1194,0 | 1194,6 |
| 100 | 1384,2 | 1385,0 | 1385,8 |
| 125 | 1478,5 | 1479,4 | 1480,3 |

For the CT6-P outdoor temp sensor

| Temperature (°C) | Resistance Min. (kΩ) | Resistance Nom. (kΩ) | Resistance Max. (kΩ) |
|------------------|----------------------|----------------------|----------------------|
| -25 | 901,6 | 901,9 | 1000,2 |
| -20 | 921,3 | 921,6 | 921,9 |
| -10 | 960,6 | 960,9 | 961,2 |
| 0 | 999,7 | 1000,0 | 1000,3 |
| 25 | 1096,9 | 1097,3 | 1097,7 |
| 50 | 1193,4 | 1194,0 | 1194,6 |
| 100 | 1384,2 | 1385,0 | 1385,8 |
| 125 | 1478,5 | 1479,4 | 1480,3 |
| 150 | 1572,0 | 1573,1 | 1574,2 |

External Control

Connection of the Standby boiler

The control unit can control operation of a standby boiler (e.g. a gas, oil boiler or heat pump). The standby boiler will activate in auto mode when an active alarm occurs in the pellet boiler, allowing its further operation and after the temperature decrease in the pellet boiler below the following:

Service Settings → Boiler settings → Reserve boiler

The standby boiler installation should be performed by a qualified installer, in accordance with the technical specifications of this boiler. Connect the standby boiler via the relay to the terminals No. 46-47.

Exemplary diagram of a system for connecting the standby boiler to the control unit

1. ecoMAX controller
2. standby boiler (e.g. a heat pump, gas or oil boiler)
3. RM 84-2012-35-1012 relay and GZT80 RELPOL base

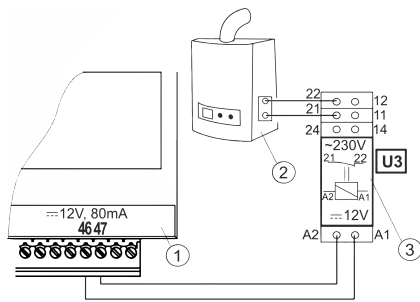

The standard control unit is supplied without the relay. Control of the standby boiler is activated by setting function of the H output to the standby boiler.

Service Settings → H output → Reserve boiler

The standby boiler is activated by removing voltage from terminals No. 46-47. Switching the standby boiler OFF is obtained by applying voltage to terminals No. 46-47.

Wiring diagram of the standby boiler diverting valve control

1. ecoMAX controller
2. standby boiler
3. relay
5. diverting valve actuator (with limit switches); note: terminals #22,2&,24 must be galvanically isolated from terminals #12,11&14.

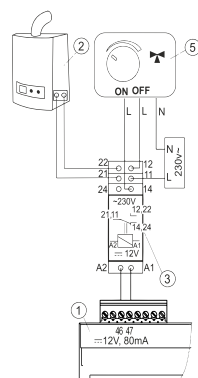

3-way valve output with actuator

The control unit only operates with mixing valve actuators with limit switches installed. Control of other actuators is forbidden. An actuator with the range of the full revolution time between 10 and 255 sec can be used.

Connection of the mixing valve:

1. Connect the mixing valve temp sensor.
2. Make electrical connections of the mixing valve pump.
3. Activate the control unit and select proper type of control for the mixing valve.

Service Settings → Mixer Settings

4. Enter the correct valve opening time in the mixing valve service settings (the time should be specified on the actuator nameplate, e.g..120 sec).
5. Connect power to the control unit and switch the pump ON from the control unit.
6. Find the direction, in which the actuator opens/closes. To do it, switch the actuator to the manual operation with the switch on its housing and find the position, in which the mixing valve circuit temperature is max (it corresponds to the position 100% ON in the control unit) and the position of the valve, where the mixing valve circuit temperature is min (it corresponds to the position 0% OFF in the control unit). Remember these positions for the subsequent verification of proper connection.
7. Disconnect power from the control unit
8. Make electrical connection between the mixing valve actuator and the control unit acc. to the valve actuator manufacturer's specification. Do not confuse the opening direction with the closing direction
9. Connect power to the control unit and switch it to STANDBY mode
10. Check, whether the mixing valve closing and opening lines are not swapped. Enter MENU → Manual Control and open the mixer by selecting Mixer Opening = ON. The temperature on the mixing valve sensor should increase at the opening. Otherwise, disconnect power from the control unit and replace the hoses (note: incorrectly mechanically connected valve can be another reason!)
11. Check in the valve manufacturer's documentation, whether the valve is connected correctly.



CAUTION

When connecting the mixer actuator, make sure that the boiler does not overheat, which can happen when the flow of boiler water is limited. Before starting work, it is recommended to know the position of the valve corresponding to the maximum opening, in order to be able to ensure heat collection from the boiler by its maximum opening at any time.

Connection of Alarm Indication

The control unit can indicate various alarm conditions by activating an external device, such as bell or GSM device sending an SMS. Connect the alarm indicating device via a relay.

Alarm indication feature can be activated by setting the function of the H output to alarms.

Service Settings → H Output

Connection of an external alarm indicating device

1. control unit
2. external alarm indicating device
3. relay

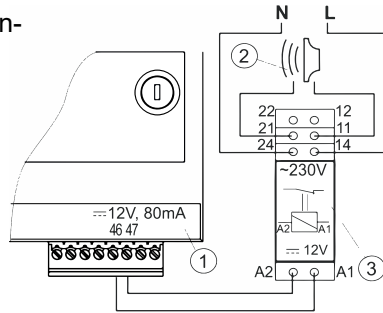

Then, in order to achieve correct operation, select the desired alarms, after occurrence of which, the signalling output should be activated:

Service Settings → Boiler Settings → Alarms

Table below:

| | |
|------|-------------------------------|
| AL 1 | Max. temp. of boiler exceeded |
| AL2 | Fan damaged |
| AL3 | Boiler sensor damage |
| AL4 | Firing-up attempt failure |
| AL5 | STB activated |
| AL6 | Broken feeder fuel system |
| AL7 | Minimum vacuum exceeded |
| AL8 | Maximum vacuum exceeded |
| AL9 | Maximum pressure exceeded |
| AL10 | Exhaust fan damaged |
| AL11 | Grate blocked |
| AL12 | Vacuum sensor damaged |
| AL13 | Max. temp. of fumes exceeded |
| AL14 | Fumes sensor damage |

Connection of the Room Panel

You can connect the optional ecoSTER TOUCH panel to the controller that can serve as:

1. room thermostat
2. boiler control panel
3. alarm indicator
4. fuel level indicator

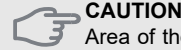

CAUTION

Area of the 12VDC and GND conductors for the connection of the room panel should be at least 0,5mm².

Maximum length fo cables should not exceed 30 m. The length may be greater if conductors with the area greater than 0.5mm² are used.

4-Wire Connection :

Connect the 4x0.5 mm² cable in accordance with the wiring diagram in chapter **Wiring Diagrams**.

2-Wire Connection:

2-wire connection requires nuse of a 12 VDC power supply with min current of 200mA. Panel supply points: connect GND and VCC to an external power supply (not included.) Connect lines D+ and D- as shown in the wiring diagram in chapter **Wiring Diagrams**.

Wireless connection of the room panel



The wireless radio connection of the eSTER_x80 panel and the eSTER_x40 thermostat requires connection to the ISM_xSMART radio module controller in accordance with the wiring diagram and pairing between the panel / thermostat and the radio module. To do this, enter the menu:

General settings → Radio module settings → Pairing Mode

and by confirming YES activate the pairing function. Further description of the operation of the wireless panel and the thermostat can be found in the relevant instruction manual for these devices.

13. Boiler settings

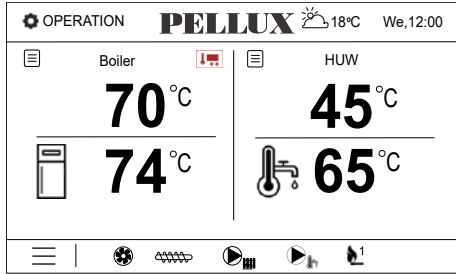
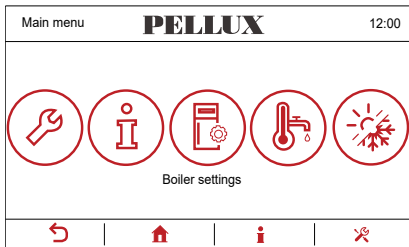
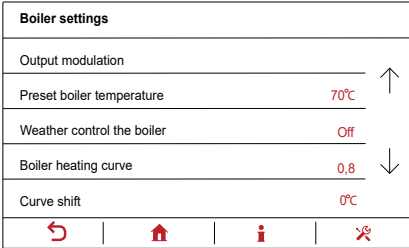
When the boiler is started for the first time, the controller has set default settings. To change the boiler settings, go to **Main menu** and then in **Boiler settings**.

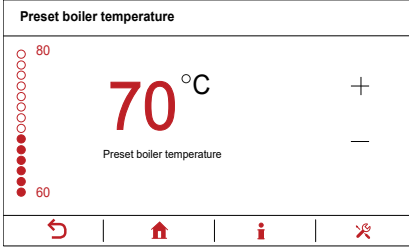
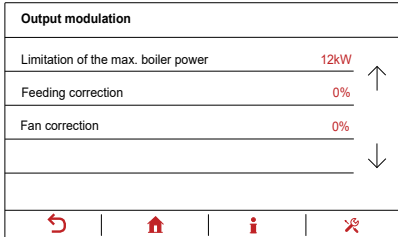
| The order of activities | Menu |
|--|---|
| <p>1. Touch Menu on the Home panel in order to pop-down the Main menu.</p> |  <p>The screenshot shows the PELLUX OPERATION interface. At the top, it displays 'OPERATION PELLUX' with a weather icon and '18°C We, 12:00'. Below this, there are two columns: 'Boiler' and 'HUW'. Under 'Boiler', the current temperature is 70°C and the setpoint is 74°C. Under 'HUW', the current temperature is 45°C and the setpoint is 65°C. A bottom navigation bar contains several icons.</p> |
| <p>2. When the Home menu appears, touch the subsequent menu features until the Boiler Settings appear. Touch the found icon displayed in the middle of the controller in order to pop-down the boiler settings menu.</p> |  <p>The screenshot shows the 'Main menu' for PELLUX at 12:00. It features five circular icons in a row: a wrench, an information 'i' icon, a boiler icon, a thermometer, and a sun. Below the icons is the text 'Boiler settings'. A bottom navigation bar is visible.</p> |
| <p>3. When in the rotary menu, select the Preset boiler temperature icon and touch it to enter to edition of the temperature setpoint.</p> |  <p>The screenshot shows the 'Boiler settings' menu. It lists several adjustable parameters: 'Output modulation', 'Preset boiler temperature' (70°C), 'Weather control the boiler' (Off), 'Boiler heating curve' (0,8), and 'Curve shift' (0°C). Each parameter has an up or down arrow for adjustment. A bottom navigation bar is present.</p> |
| <p>4. After selecting the Preset boiler temperature feature, you can edit it. Touch the “+” symbol to increase the temperature setpoint or the “-” symbol to decrease the temperature setpoint. Acknowledge the change after editing the temperature setpoint by touching  bottom.</p> |  <p>The screenshot shows the 'Preset boiler temperature' editing screen. It features a vertical scale of red dots from 60 to 80. The current setpoint is 70°C. There are '+' and '-' buttons for adjustment. A bottom navigation bar is visible.</p> |
| <p>5. When in the slide menu, select the Output modulation. The menu includes parameters such as: Limitation of the max. boiler power, Feeding correction or fan correction.</p> |  <p>The screenshot shows the 'Output modulation' menu. It lists three parameters: 'Limitation of the max. boiler power' (12kW), 'Feeding correction' (0%), and 'Fan correction' (0%). Each parameter has an up or down arrow for adjustment. A bottom navigation bar is present.</p> |

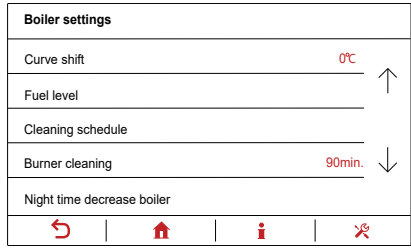
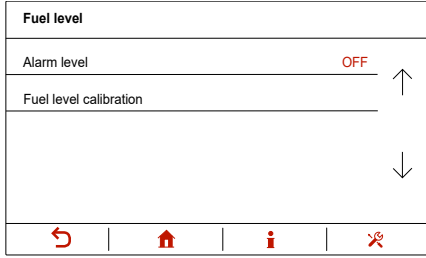
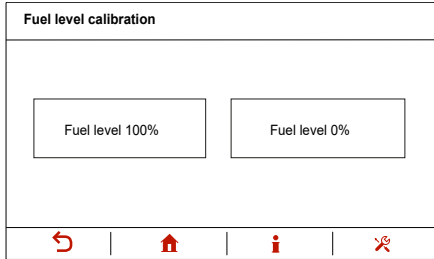
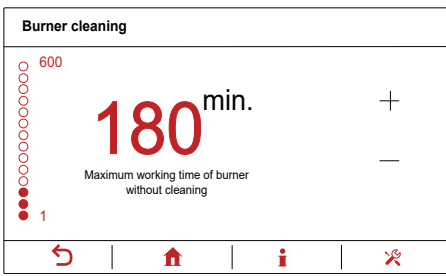
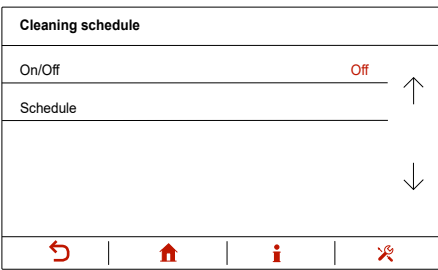
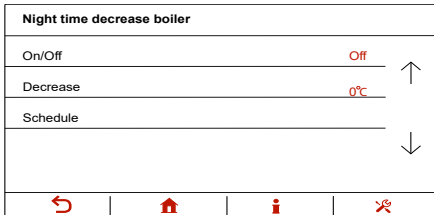
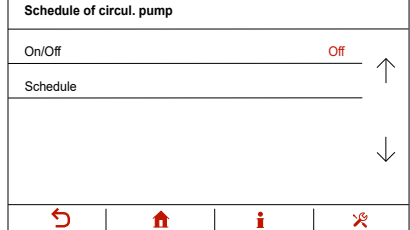
| | |
|---|--|
| <p>6. After returning to the rotary menu Boiler Settings, go to the Fuel Level feature. You can toggle between two features in the Fuel Level option: Alarm Level and Fuel Level Calibration</p> |  |
| <p>7. Alarm Level is the first option. This feature sets the fuel level threshold, at which the alarm following will be displayed in the centre of the controller panel: LOW FUEL LEVEL. In order to increase the fuel alarm level, touch the + symbol and, to decrease it, touch the – symbol. Confirm the change after editing by touching OK on the bar at the bottom.</p> |  |
| <p>8. Fuel Level Calibration allows manual calibration of the fuel level in the dispenser. Fill up the dispenser first and set the FUEL LEVEL 100 %. When the minimum fuel level remains in the dispenser after a period of regular operation of the boiler, select FUEL LEVEL 0 %. The control unit itself will calculate the fuel level in the dispenser after calibration.</p> |  |
| <p>9. After returning to the rotary menu Boiler Settings, go to the Burner Cleaning option. In this feature, you can select continuous operation of the burner followed by automatic extinguishing, cleaning and new firing up. In order to increase the burner operation time, touch + and to decrease the time, touch –. Acknowledge the time change after editing by touching OK on the bar at the bottom.</p> |  |
| <p>10. After returning to the rotary menu Boiler Settings, go to the Cleaning Schedule option. This feature allows defining the burner cleaning schedule for a selected day. After defining the schedule, switch it ON and confirm by touching OK on the bar at the bottom.</p> |  |
| <p>11. After returning to the rotary menu Boiler Settings, go to the Boiler Night Decrease option. This feature allows a schedule for decreasing the boiler temperature setpoint for each weekday. To do this, specify the decrease value (between 0°C and 20°C) and define a schedule for each weekday. After specifying the schedule, activate the night decrease option by setting the On/Off to On.</p> |  |
| <p>12. After returning to the Boiler Settings menu, go to the Schedule of circul. pomp. This function allows you to program the working schedule of the HUW circulation pump. The HUW circulation pump enables the quick appearance of hot water in parts of the building distant from the boiler room.</p> |  |

Boiler settings

| | |
|----------------------------|-------------------------------------|
| Output modulation | Limitation of the max. boiler power |
| | Feeding correction |
| | Fan correction |
| Preset boiler temperature | Temperature preset |
| Weater control the boiler* | On/Off |
| Boiler heating curve* | Curve selection |
| Curve shift* | Parallel shift selection |
| Room temperature factor* | |
| Fuel level | Alarm level |
| | Fuel level calibration |
| Burner cleaning | |
| Cleaning schedule | On/Off |
| | Schedule |
| Lambda probe calibration* | |
| Night time decrease boiler | On/Off |
| | Decrease |
| | Schedule |
| Schedule of circul. pump | On/Off |
| | Schedule |

HUW settings*

| | |
|-------------------------|------------------------------|
| HUW preset temperature | |
| HUW pump mode | Off / Priority / No priority |
| HUW cont. hysteresis | |
| HUW disinfection | On / Off |
| Night time decrease HUW | On/Off |
| | Decrease |
| | Schedule |

* unavailable, unless the corresponding sensor or additional module is connected or the parameter is hidden

Summer mode

| | |
|--------------------------------|-------------------------|
| Summer mode | Winter / Summer / Auto* |
| SUMMER mode act. temperature | Temperature preset |
| SUMMER mode deact. temperature | Temperature preset |

Mixer 1-5 settings*

| | |
|-------------------------------|------------------------------|
| Preset mixer temperature | Weather controler turned off |
| Mixer room therm. | |
| Mixer weather control* | |
| Heating curve. mixer* | |
| Curve translation* | |
| Room temperature coefficient* | |
| Mixer night time decrease | On/Off |
| | Decrease |
| | Schedule |

General settings

| | |
|-----------------------|--------------------------------|
| Clock | Allows to set the current time |
| Date | Allows to set the current date |
| Brightness | |
| Sound | On / Off |
| Language | Allows to set language |
| Software update | Update selection |
| WiFi settings* | |
| Radio module setting* | Pairing mode |
| | Delete device associations |

CHIMNEY SWEEP mode

| | |
|-----------------------|--------|
| CHIMNEY SWEEP mode | On/Off |
| Boiler output setting | |
| Worktime | |

* unavailable, unless the corresponding sensor or additional module is connected or the parameter is hidden

14 Service



CAUTION

Only authorized person should use the service menu.

Service settings

| Service settings | Boiler settings |
|------------------|---------------------------|
| | CH and HUW settings |
| | Buffer settings* |
| | Mixer settings 1-5* |
| | Return protection |
| | H output* |
| | Show advanced setup |
| | Display orientation |
| | Restore defaults settings |

Boiler settings

| Output modulation | Feeder cycles |
|-------------------|-------------------------------|
| | Maximum boiler output |
| | The intermediate boiler power |
| | Minimum boiler output |
| | Blow-in fan output 100%** |
| | Vacuum 100%** |
| | 100% Oxygen* |
| | Blow-in fan output 50%** |
| | Vacuum 50%** |
| | 50% Oxygen* |
| | Blow-in fan output 30%** |
| | Vacuum 30%** |
| | 30% Oxygen* |
| | 50% H2 hysteresis |
| | 30% H1 hysteresis |
| | Boiler hysteresis |
| | Regulation mode |
| | Room thermostat |

| Firing-up | Fuel dose |
|-----------|----------------------------------|
| | Ignitation test time |
| | Igniter pre-heating time |
| | Firing-up time |
| | Feeder time in firing-up |
| | Incandescence time |
| | Blow-in fan output INCANDESCENCE |
| | Fumes delta |
| | Blow-in output in fire-up |
| | Vacuum in fire-up |
| | Blowin output after fire-up |
| | Vacuum after fire-up |

Ustawienia kotła cd.

| | |
|---------------------------------------|--|
| Cleaning | Exchanger cleaning - work |
| | Movable grate - work |
| | Grate cleaning cycles |
| Burning off | Blow-in fan output during burning off |
| | Vacuum during burning off |
| | Minimum burning off time |
| | Burning off start detection |
| | Burning off stop detection |
| Supervision | Burning off delta |
| | Supervision time |
| | Boiler output in Supervision mode |
| | Cycle time SUPERVISION |
| Other | Blow-in fan output SUPERVISION |
| | Vacuum SUPERVISION |
| | Minimum airflow output |
| | Maximum airflow output |
| | Vacuum sensor |
| | Minimum fan output |
| | Maximum fan output |
| | Minimum preset vacuum |
| | Minimum vacuum (alarm) |
| | Maximum vacuum (alarm) |
| | No fuel detection time |
| | Treshol flame no fuel |
| | Enhancement fan (PI) |
| | Integration time constant |
| Vacuum correction | |
| Enhancement exhaust fan (PI) | |
| Integration time constant exhaust fan | |
| Thermostat select.: | Off / Universal / ecoSTER T1-T3, eSTER T1-T3 |
| Min. boiler temperature | |
| Max. boiler temperature | |
| Boiler cooling temperature | |
| Reserve boiler | |
| Alarms | |

* unavailable, unless the corresponding sensor or additional module is connected or the parameter is hidden

** RPM or %

| |
|------------------------|
| Feeder efficiency test |
| Energy density |
| Feeder efficiency |
| Tank capacity |
| Parameter A FuzzyLogic |
| Parameter B FuzzyLogic |
| Parameter C FuzzyLogic |

CH and HUW settings

| |
|------------------------------------|
| CH pump activation temperature |
| Minimum HUW temperature |
| Maximum HUW temperature |
| Boiler inc. by HUW, Mixer |
| Extending HUW pump operation time |
| Circulating pump standstill time * |
| Circulating pump operation time * |
| Exchanger |

Return protection

| |
|-----------------------------|
| Return protection |
| Minimum preset return temp. |
| Return temp. hysteresis |
| Valve closing |

Buffer settings

| |
|---------------------------|
| Buffer support |
| Loading start temperature |
| Loading end temperature |
| Start heat installation |

* unavailable, unless the corresponding sensor or additional module is connected or the parameter is hidden

Mixer settings 1-5*

| | |
|-------------------------|--------------------------------------|
| Thermostat select.: | Disabled / Universal / ecoSTER T1 |
| Mixer support | Off / On CH / On. Floor. / Pump only |
| Min. mixer temp. | |
| Max. mixer temp. | |
| Valve full opening time | |
| Off by thermostat | No / Yes |
| Mixer input dead zone* | |

H output*

| | |
|-----------|--|
| H output* | Kocioł rezerwowy / Circulating pump / Alarms |
|-----------|--|

Show advanced setup

| | |
|---------------------|----------|
| Show advanced setup | Yes / No |
|---------------------|----------|

Display orientation

| | |
|---------------------|-------------------|
| Display orientation | Normal / Inverted |
|---------------------|-------------------|

Restore defaults settings

| | |
|---------------------------|---------------------------|
| Restore defaults settings | Acceptance / Cancellation |
|---------------------------|---------------------------|

* unavailable, unless the corresponding sensor or additional module is connected or the parameter is hidden

Service settings

Boiler settings

| OUTPUT MODULATION | Description |
|---------------------------------------|---|
| Feeder cycles | By default: 12 seconds (max 250 seconds). |
| Maximum boiler output | Determining the maximum power at which the boiler can work. |
| Blow-in fan output 100 % | Air blower output at 100 % of the boiler output; by default: 1400 RPM (max 2850 RPM). |
| Vacuum 100% | Combustion chamber vacuum at 100% boiler output; by default: 12 Pa (255 Pa maximum). |
| The intermediate boiler power | Determination of the indirect power with which the boiler can work. |
| Blow-in fan output 50 % | Air blower output at 50 % of the boiler output; by default: 1150 RPM (max 2850 RPM). |
| Vacuum 50% | Combustion chamber vacuum at 100% boiler output; by default: 10 Pa (255 Pa maximum). |
| Minimum boiler output | Determining the minimum power with which the boiler can work. |
| Blow-in fan output 30 % | Air blower output at 30 % of the boiler output; by default: 1000 RPM (max 2850 RPM). |
| Vacuum 30% | Combustion chamber vacuum at 100% boiler output; by default: 7 Pa (255 Pa maximum). |
| 50 % H2 Hysteresis | Temperature threshold for the transition from the max burner output to the half burner output; by default: 5°C (max 30°C). |
| 30 % H1 Hysteresis | Temperature threshold for the transition from the half burner output to the min burner output; by default: 3°C (max 30 °C). |
| Boiler Hysteresis | If the boiler temperature drops below the boiler temperature setpoint by the boiler hysteresis value, the burner is fired up in auto mode; by default: 10°C. |
| Regulation mode | Standard mode consists of 3-stage modulation of the burner output, while FUZZY LOGIC mode consists of stepless output control basing upon a PID algorithm; by default: Fuzzy Logic. |
| Room Thermostat | Decrease of the boiler temperature setpoint controlled by the thermostat; by default: 0 °C (max 30 °C). |
| Opóźnienie obniżenie mocy wentylatora | Number of work cycles after which the fan power will decrease while the boiler power is reduced. |

| Output modulation | |
|-------------------------------|-------------------|
| Feeder cycles | 12 sec. ↑ |
| Maximum boiler output | 12 kW (4.4sec.) ↑ |
| The intermediate boiler power | 6 kW (2.2sek.) ↓ |
| Minimum boiler output | 3 kW (1.1sek.) ↓ |
| Blow-in fan output 100% | 1400 r/min |
| | |

| Output modulation | |
|------------------------|-------------|
| Vacuum 100% | 12Pa ↑ |
| Blow-in fan output 50% | 1150r/min ↑ |
| Vacuum 50% | 10Pa ↓ |
| Blow-in fan output 30% | 1000r/min ↓ |
| Vacuum 30% | 7Pa |
| | |

| Output modulation | |
|-------------------|---------------|
| 50% H2 Hysteresis | 5°C ↑ |
| 30% H1 Hysteresis | 3°C |
| Boiler hysteresis | 10°C |
| Regulation mode | Fuzzy Logic ↓ |
| Room thermostat | 0°C |
| | |

| Output modulation | |
|---------------------------------------|-------------|
| 30% H1 Hysteresis | 3°C ↑ |
| Boiler hysteresis | 10°C |
| Regulation mode | Fuzzy Logic |
| Room thermostat | 0°C ↓ |
| Opóźnienie obniżenie mocy wentylatora | 0 |
| | |

| FIRING-UP | Description |
|---------------------------------------|---|
| Fuel dose | Fuel dose during firing up. Concerns first testing firing up. Next tests fuel dose is reduced (by default: Pellux Slim 12 - 100 g, Pellux Slim 18 - 140 g). |
| Ignition test time | Time of verification whether the furnace has already been fired up (change in exhaust gas temperature by a delta 2.5 °C). |
| Igniter pre-heating time | Time of heating the igniter before switching the air blower ON. It should not be too long to not damage the heater. The heater still operates after this time, until the flame detection (temperature increase by the firing up delta). |
| Firing-up time | Time of a single attempt to fire up. After this time, controller proceeds to another attempt to fire up. After the failure to all attempts to fire up, the alarm: "Failed to fire up" is reported. |
| Feeder time in fire-up | Fuel feeding time during firing-up. |
| Incandescence time | Time of the incandescence after detecting the flame in the ignition phase. |
| Blow-in fan output INCANDESCENCE | Blower fan power during incandescence of the furnace in rpm. |
| Fumes delta | The parameter determines by how much the exhaust gas temperature must rise before a flame is detected. |
| Blow-in output in fire-up | Airflow output at fire up in RPM. Too high value slows down the fire up process or results in failed fire up attempt. |
| Vacuum in fire-up | Vacuum when firing up the furnace in Pa. |
| Blow-in output after fire-up | RPM of air blower airflow blow after a flame detection. |
| Vacuum after fire-up | Vacuum after firing up in Pa. |
| CLEANING | Description |
| Exchanger cleaning - work | Duration of cleaning that follows the completed blow-by. |
| Movable grate - work | Working time of the movable grate. |
| Grate cleaning cycles | Grate cleaning cycles. The cycle consists of the working time and the break time. |
| BURNING OFF | Description |
| Blow-in fan output during burning off | Air blower speed at damping in RPM. |
| Vacuum during burning off | Vacuum of the combustion chamber during extinguishing. |
| Minimum burning off time | Damping the fire will continue for at least this time, although the flame sensor has already indicated lack of flame. |
| Burning off start detection | Temperature threshold at which the controller starts measuring the exhaust gas temperature drop by the extinguishing delta. |
| Burning off stop detection | Temperature threshold, below which the controller ignores the extinguishing detection delta and a flame failure is detected. |
| Burning off delta | The parameter determines by how much the flue gas temperature must drop in order to detect extinction. |

| SUPERVISION | Description |
|-----------------------------------|---|
| Supervision time | After the lapse of the monitoring time, the controller goes into the BURNING OFF mode and then, into the STOP mode. If the monitoring parameter = 0, the SUPERVISION mode is skipped and the unit goes directly into the BURNING OFF mode. If the monitoring parameter = 60, then the regulator remains in the SUPERVISION mode for 60 minutes, then it switches to the BURNING OFF mode. |
| Boiler output in Supervision mode | Power with which the boiler works during the SUPERVISION mode. It should be as small as possible, but large enough to prevent the flame from extinguishing. |
| Cycle time SUPERVISION | Time of operation of the feeder in the MONITORING mode. Cycle time: Monitoring = time of supply in Monitoring + feeder standstill time in Monitoring. |
| Blow-in fan output SUPERVISION | % of air blower output in the SUPERVISION mode; too high value can cause the boiler overheating or withdrawal of flame into the feeder; too low value can cause the fuel overflow. Select the value so, as to fire the fuel supplied in the Monitoring mode with low emissions. |
| Vacuum SUPERVISION | Vacuum in the SUPERVISION mode in Pa. |
| LAMBDA SENSOR | Description |
| Operation with Lambda sensor | If the parameter is set to ACTIVATE, the controller operates with the use of the Lambda sensor indications. The amount of air supplied to the furnace will be adjusted in auto mode to achieve the preset value of oxygen content in the fuel gas. If this parameter is set to SWITCH OFF, the Lambda sensor indications do not affect the controller operation. |
| Dynamics | It affects the rate of regulation of the amount of oxygen in the exhaust to the set point and the stability of maintaining the oxygen content in the exhaust. It is not recommended to change this parameter if the control rate and the stability of maintaining the oxygen setpoint are at the expected level. |
| Reaction time | It affects rate of control of oxygen content in the flue gas to the preset value and the stability of maintaining oxygen content in the flue gas. Change of this parameter is not recommended, if the rate of control and the stability of maintaining oxygen content preset value are at the expected level. |
| Airflow correction range | It determines the allowable airflow output range of variation when operating with the use of the Lambda sensor. |
| Other | Description |
| Minimum airflow output | Minimum airflow output in % that the controller user can select. It is only used to limit the available air blower output range. It is not used in the air blower control algorithm. It should be as low as possible, only that high to allow low speed of the air blower with free rotation and without any 'humming.' |
| Maximum airflow output | Maximum airflow output in % that the controller user can select. It is only used to limit the available air blower output range. It is not used in the air blower control algorithm. It should be such as to allow the air blower rotate at relatively high speed without any noises. |
| Vacuum sensor | This parameter allows you to enable or disable the vacuum sensor in the boiler. |
| Minimum preset vacuum | Minimum preset vacuum. |
| Minimum vacuum (alarm) | The minimum negative pressure at which an alarm is triggered. |
| Maximum vacuum (alarm) | Maximum negative pressure beyond which an alarm is triggered. |
| No fuel detection time | The time is counted down after the exhaust gas temperature drops below the No fuel exhaust temperature parameter. |
| Treshold flame no fuel | Flue gas temperature value below which no flame is detected. |

| THERMOSTAT SELECT.: | Description |
|--|--|
| Off | Switches OFF impact of the room thermostat on the boiler operation. |
| Universal | Activates the NO/NC room thermostat for the boiler. |
| ecoSTER T1-T3, eSTER T1-T3 | Option available after the connection of room panel. It makes the boiler operation dependable on the room thermostat. |
| Minimum boiler temp | The minimum boiler temperature setpoint that the user can set in the user menu as well as the minimum setpoint that the controller can set in auto mode from e.g. night decrease, weather-related control, etc. |
| Maximum boiler temp | The maximum boiler temperature setpoint that the user can set in the user menu as well as the maximum setpoint that the controller can set in auto mode from e.g. night decrease, weather-related control, etc. |
| Boiler cooling temperature | The temperature for the boiler preventive cooling. Above this temperature, the controller activates the HUW pump and opens the mixing valve circuits in order to cool the boiler down. The controller switches OFF the HUW pump when the temperature of the water exceeds the max value. The controller does not open the mixer circuit, if the mixer operation = the FLOOR ON. |
| Reserve boiler | The controller can control operation of a standby boiler. The standby boiler is activated in auto mode if an active alarm occurs in the pellet boiler preventing its further operation and after the pellet boiler temperature drop below the preset parameter. |
| Alarms | The controller can indicate alarm conditions activating an external unit. The alarm indicating device should be connected via a relay. Deactivation of alarm indication after setting the function of the H output to Alarms. |
| Feeder efficiency test | The feeder efficiency test is carried out after the feeder discharge pipe has been previously filled. Then set the Performance Test Time to a value between 5 and 10 minutes: Service settings → Boiler settings → Feeder efficiency test → Efficiency test time Then enter the „Feeder efficiency test“ and press „START“ to start the feeder operation. When the feeder is in operation, the pellets must fall directly into the empty pellet container (e.g. a bucket). The pellets in the container should be weighed and the result recorded in: Service settings → Boiler settings → Feeder efficiency test → Fuel weight |
| Energy density | The value is set depending on the used pellets. |
| Feeder efficiency | The value of the „Feeder efficiency“ is converted on the basis of the fuel weight entered after the pellet weight test and should not be changed. This parameter can be found: Service settings → Boiler settings → Feeder efficiency |
| Tank capacity | Water tank capacity to calculate the fuel level. |
| Parameter A FuzzyLogic Parameter B FuzzyLogic Parameter C FuzzyLogic | They apply to the Fuzzy Logic mode. They affect the speed of the boiler temperature reaching the set value and the stability of maintaining this temperature. It is not recommended to change these parameters if the regulation speed and the stability of keeping the temperature setpoint are at the expected level. |

| CH and HUW settings | Description |
|-----------------------------------|---|
| CH pump activation temperature | This parameter decides the temperature, at which the CH boiler pump activates. This protects the boiler against condensation due to cooling it down by the cold water returning from the system. Caution: switching the boiler pump alone does not ensure protection of the boiler against condensation and corrosion as a consequence. Use an additional protection, such as 4-way valve or 3-way thermostatic valve. |
| Minimum HUW temperature | Available after the connection of the HUW sensor. With this parameter, you can prevent possibility to set too low HUW temperature setpoint. |
| Maximum HUW temperature | Available after the connection of the HUW sensor. This parameter decides up to what maximum temperature the HUW tank will be heated during discharging heat excess from the boiler in emergency conditions. It is a very important parameter, since setting of too high its value can lead to the risk of scalding the users with the hot utility water. Too low value of this parameter will cause that, in the case of the boiler overheating, the heat excess discharge to the HUW tank will be impossible. When designing the hot water system, consider the possibility of damaging the controller. As a result of the controller failure, the water in the HUW tank may be heated up to a dangerous temperature, threatening scalding of the users. Use an additional protection, such as e.g. thermostatic valves. |
| Boiler inc. by HUW, Mixer | This parameter decides by how many degrees the boiler temperature setpoint will increase in order to fill the HUW tank, buffer and the mixing valve circuit. The temperature increase can only be implemented if required. If the boiler temperature setpoint is at a sufficient level, the control unit will not change it due to the necessity of filling the HUW tank, buffer or mixing valve circuit. Increase of the HUW tank temperature setpoint is indicated by letter C on the Home panel. |
| Extending HUW pump operation time | Available after the connection of the HUW sensor. After filling up the HUW tank and switching the HUW pump OFF, the risk of the boiler overheating can occur. It takes place when the HUW temperature setpoint is higher than the boiler temperature. In particular, this issue applies to the operation of the HUW pump in the SUMMER mode, when the CH pump is switched OFF. You can prolong the time of operation of the HUW pump of the time of operation of the HUW pump in order to cool the boiler down. |
| Exchanger | It only applies to the hydraulic systems with heat exchanger between the open and closed circuits. Options available: <ul style="list-style-type: none"> • YES (the boiler pump operates in a short circuit 'boiler/heat exchanger' and is not switched OFF by e.g. SUMMER feature or HUW priority.) • NO (the pump operates as usual.) |

| MIXER SETTINGS | Description |
|---------------------------|---|
| Thermostat select.: | <ul style="list-style-type: none"> • OFF – switches OFF the thermostat impact on the boiler operation. • Universal - activates an NO/NC room thermostat connected to terminals • ecoSTER T1-T3, eSTER T1-T3 – option available in connection with the room panel; signal on the thermostat status is sent from the room panel. |
| Mixer support | <ul style="list-style-type: none"> • OFF – the mixing valve actuator and pump do not operate. • CH OFF – it applies when the mixing valve circuit supplies a central heating system with radiators. The maximum temperature of the mixing valve circuit is not limited and the mixing valve is fully opened during alarms, e.g. the boiler overheating. Caution: do not activate this option if the system is made of pipes sensitive to the high temperature. In such situations, we recommend setting the mixing valve control to the FLOOR ON. • Floor ON – it applies if the mixing valve circuit supplies a floor heating system. The maximum temperature of the mixing valve circuit is limited to the Max Mixer Temp Setpoint parameter. Caution: after selecting the FLOOR ON option, set the Mixer Temp Setpoint to the same value to avoid damage to the floor and the risk of scalding. • Pump Only – when the mixing valve circuit temp exceeds the value set in the mixing valve temperature setpoint parameter, the mixing pump supply will be switched OFF. When the temperature in the circuit drops down by 2 °C – the pump will restart. This option is usually used to control the floor heating system if it operates with a thermostatic valve without any actuator. |
| Minimum mixer temperature | This is a parameter allowing preventing the user possibility to set too low mixing valve temperature setpoint. Auto control (e.g. periodic decrease of the temperature) does not cause any decrease of the temperature setpoint below the value set for this parameter. |
| Maximum mixer temperature | This parameter has two functions: It allows preventing the user to set too low mixing valve temperature setpoint. Auto control (adjustment along a heat curve from the outdoor temperature) also does not cause exceeding the temperature setpoint above the value set for this parameter; if the mixing valve control = OFF, the mixing valve pump will be switched OFF at the Max mixer temp. of 5 °C, which protects the floor against damage. For the floor heating, set the value not higher than 45+50 °C or lower, if the thermal resistance of the floor is lower. Note: too low parameter setting can cause unnecessary switching OFF's of the pump. |
| Valve full opening time | Enter the time of full opening of the valve from the valve nameplate, e.g. 140 sec. |
| Off by thermostat | Setting this parameter to YES closes the mixing valve actuator and switches the mixing valve pump on opening of the room thermostat contacts (i.e., the room is heated). However, this operation is not recommended, since the room may be cooled down too much. |
| Mixer input dead zone | Setting of this parameter determines the temperature insensibility (dead zone) for the mixing valve control system. The control unit controls the mixing valve so, as the temperature value measured by the mixing valve sensor was equal to the setpoint. However, in order to avoid too frequent actuator movements that could shorten its life, the control is activated only if the mixing valve circuit measured temperature is higher or lower than the setpoint value by the value exceeding the mixing valve insensibility. |

| BUFFER SETTINGS | Description |
|--|---|
| Buffer support: | This parameter is for activation of operation with the buffer option. It is available after the connection of the optional B module and buffer temperature sensors. |
| Loading start temperature Loading end temperature | The Buffer Filling Start Temp parameter defines the top limit of the buffer temperature, below which the buffer filling procedure begins. This process ends at the moment when the lower limit of the buffer temp reaches the valve defined in the Buffer Filling Stop Temp parameter. |
| Start heat installaton. | Temperature below which the heating system is switched off. Measured in the upper part of the buffer. |
| Return protection | Description |
| Return protection | Option enable protection return. In the case included the protection of no return temperature sensor mixer 2. 3D protection directly behind the boiler, 4D protection at all mixer. Caution: never activate this option if there is no electric actuator on the valve installed! |
| Return temp hysteresis | The electric actuator returns to normal operation at the return temperature \geq min return temperature + return hysteresis. |
| Minimum preset return temp. | The boiler return temperature, below which the electric actuator slightly closes the mixing valve. |
| Valve closing | This is a % of the mixing valve opening during the activation of the return feature. Set such a value that the return temperature might increase. Note: the return line protection feature will operate if the boiler temperature set-point is set high enough. Otherwise, it results in frequent closing of the actuator. Note: the valve closes with the accuracy of ± 1 %. |
| H OUTPUT | Description |
| Reserve boiler | Outputs No. 46-47 control the standby boiler. This option is active if the H1 output = standby boiler; it specifies the solid fuel boiler temperature, above which the standby boiler is activated. When used with a buffer, it specifies the buffer operating temperature, above which the standby boiler is switched ON/OFF. |
| Alarms | Outputs No. 46-47 is activated if an alarm occurs. This option is active if the H1 output = alarms; it allow selection of alarms, to which the H1output has to react. |
| Circulating pump | Output 46-47 controls the circulation pump |
| Show advanced setup | Description |
| Show Advanced | Options available: <ul style="list-style-type: none"> • YES (displays hidden parameters, edition of which is not recommended) • NO (hides the hidden parameters) |
| DISPLAY ORIENTATION | Description |
| Display orientation | Options available: <ul style="list-style-type: none"> • Normal • Inverted (screen inverted by 180°). |
| RESTORE DEFAULTS SETTINGS | Description |
| Restore defaults settings | Acknowledgment of this setting restores all default settings of the control unit parameters. |

Software update

Software update can be done with a microSDHC type memory card only.

Inserting a microSDHC memory card

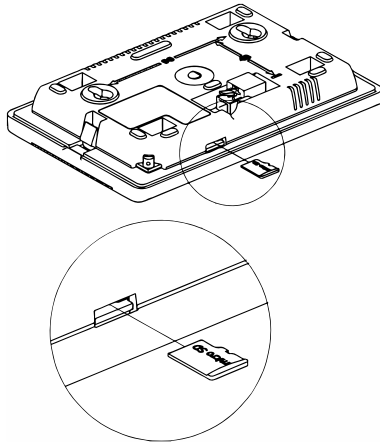

CAUTION
The software may only be replaced by an authorized person with all precautions against electric shock!

To update software, disconnect the controller's power supply. The software can be changed by inserting a microSD card into the ecoTouch, ecoSTER Touch, eSTER_x80 boiler panel. Insert the memory card into the indicated slot. A new software in .pfc format should be saved on the memory card in the form of two files: a file with the panel program and a file with the program for the module A of the regulator. Place the new software directly on the memory card without nesting the data in the child directory. Then reinstall the panel in the controller housing and connect the mains supply. Go to:

General settings → Software update

and program exchange first in module A of the controller and then in the controller's panel and other devices (eg. ecoSTER).

Loss of Voltage

In the event of a power outage, when the boiler was working in mode, the controller will go into BURNING OFF. Then, if necessary, it will proceed to the process FIRING UP. When the boiler was in the PURGE, the controller will return to this mode.

Anti-Frost Protection

If the boiler temperature drops below 5°C, the boiler pump will be activated forcing the boiler water circulation. The burner is activated when the temperature rises.

CAUTION
This feature must not be the only protective measure against the system freezing! Use also another methods. The manufacturer shall not be liable for any damages associated with this.

Pump Protection Against Sticking

The controller features the CH, HUW pumps and MIX-ER protection against sticking. It consists of periodic activation of these devices (every 167 h for several seconds). This protects the pumps against sticking due to the limescale build-up. Therefore, if the boiler is not to be used for a longer period of time, the controller supply should be connected. This feature is also available with the controller switched OFF from the keypad (the controller in the STOP mode.)

Fuse Replacement

The mains fuse is located in the controller housing. It may only be replaced by appropriately certified personnel after isolating the controller from the mains. Use time delay fuses, made of porcelain, size 5x20mm and with rated blow out current 6.3A.

Replacement of the Control Panel

When replacing the display or module, you must have a SD card with the latest software. Both the module and the display must be updated to be compatible with each other.

Connecting Accessories

Connecting the B/C Module

The optional B module is provided for the control of:

- mixer #2,3 pump
- mixer #2,3 actuator
- controlled circuit temperature sensor (mixer #2,3)
- room thermostat of mixer #2,3
- HUW circulating pump

CAUTION
 All additional modules (B, C or λ) should be installed in a separate box, with separate supply.

Buffer

CAUTION
 The buffer tank is available as accessory. After its incorporation into the heating system, it can be controlled from the boiler control panel.

Activation of the buffer tank from the control panel:

Service Settings → **Buffer Settings** → **Buffer support (NO/YES)**

CAUTION
 Only a qualified installer may set the service settings of the buffer tank. Incorrect settings may lead to damage to the system.

Accessory Activation

Each of the connected accessories requires activation from the control panel.

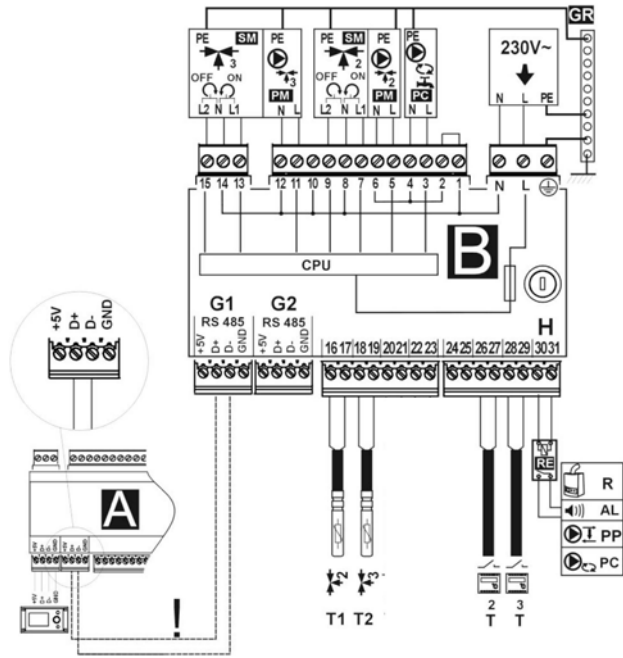

| Designation | Explanation |
|-------------|---|
| B | module for handling additional heating circuits |
| λ | Lambda sensor module |
| L N PE | 230VAC mains supply |
| T1 | CT4 controlled circuit temp sensor (mixer #2) |
| T2 | CT4 controlled circuit temp sensor (mixer #3) |
| T | mixer room thermostat |
| SM | Mixer actuator |
| PM | Mixer pump |
| PC | HUW circulating pump |
| H | Voltage output |
| RE | Relay (5-6V, max 80mA) |
| R | Reserve boiler |
| AL | Alarm signaling |
| A | ecoMAX controller, A module, G3 socket |

Lambda Module



CAUTION

Use only dedicated temperature sensors or their equivalents for all optional modules.

Activation of the Lambda Sensor Module

After the installation of the Lambda sensor module, some adjustments in the control panel settings are required.

Service Settings → **Boiler Settings** → **Lambda Sensor** → **Operation with Lambda Sensor**

The Lambda module is already preconfigured. The Lambda sensor can be connected in the Plug and Play mode.

The module can be supplied with 230VAV, 50Hz. Connect supply voltage to the L and N terminals. Communication of the module with other units is performed via the RS485 communications. Cables for connecting the units included. The Comm circuits can be connected in two ways: via the RJ-11 connector and then, it can be serviced as standard phone connections, or as a spring connector on the terminal strip. For the signal distribution in the RJ11 connector and the terminal strip, see the relevant diagrams. If the supplied cable is too short, use a phone cable (4-wire) with RJ11 plugs and with the length not exceeding 10m.

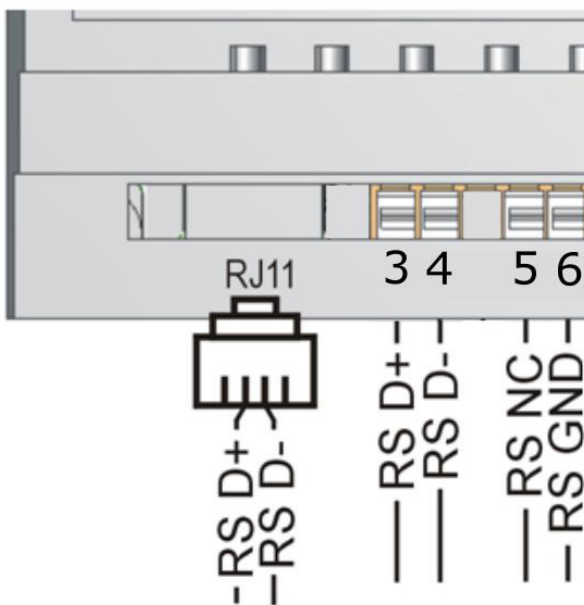

ecoLambda 2B.

Connecting the Lambda Sensor

The ecoLambda Module operates with the Lambda sensor type NGK included. The ecoLAMBDA 2B Module only operates with the Lambda sensor type NGK included. Use of a Lambda sensor of other type does not guarantee the reliability of measurements. For the wiring diagram for the connection of the sensor to the ecoLAMBDA Module, see the diagram below.

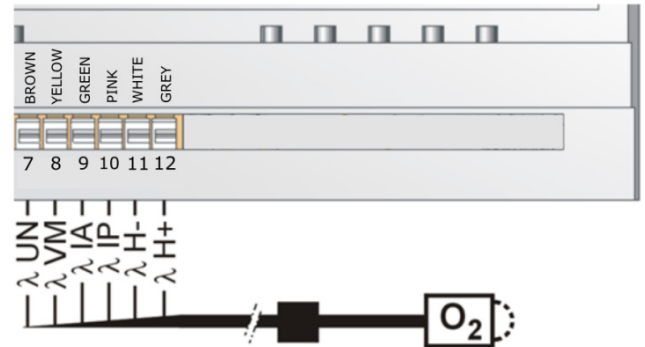

ecoLambda 2B

| Connection to the ecoLAMBDA Module | |
|------------------------------------|-------------|
| Output | Wire colour |
| Type of sensor: NGK ZFAS-U2 | |
| λ H+ | Grey |
| λ H- | White |
| λ IP | Rose |
| λ IA | Green |
| λ VM | Yellow |
| λ UN | Brown |

Calibration of Lambda probe

The calibration process can be carried out only when the boiler is switched off. The following parameter is used to start the calibration:

Boiler settings → **Lambda calibration**

The area must be completely extinguished. The fan will start and the lambda probe will start working. The fan exhales the exhaust from the chimney, leaving clean air in which the oxygen content should be 20.9% + -0.1%. After measuring the oxygen value, the fan turns off and the lambda sensor goes into stop mode. The whole calibration process takes about 8 minutes. The boiler can be restarted.

Boiler (STB) and Feeder Temperature Limiters

Resetting of the boiler temperature limiter (STB)

CAUTION
Tripping of the boiler's temp limiter warns of incorrect operation of the System, which requires investigation.

1. The STB temp limiter is available behind the inspection cover on the right side of the boiler.

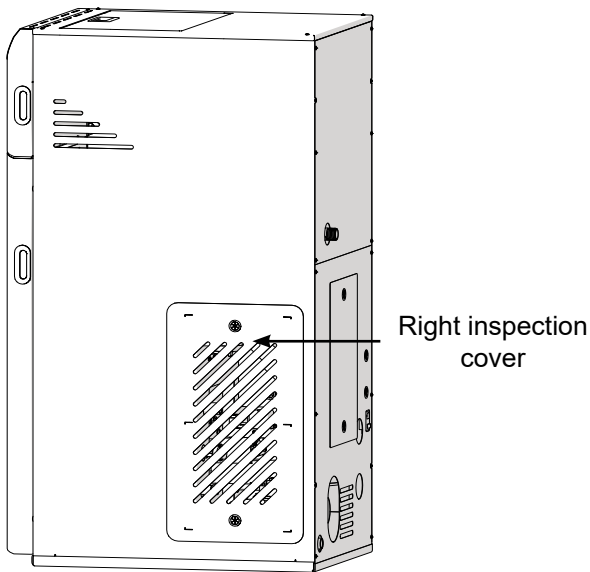

2. Turn off the boiler and disconnect the boiler power supply cables.
3. Remove the inspection cover. The cover is attached from the inside on the catches. Slide the cover to the left and then tilt it towards you to slide the cover to the right.

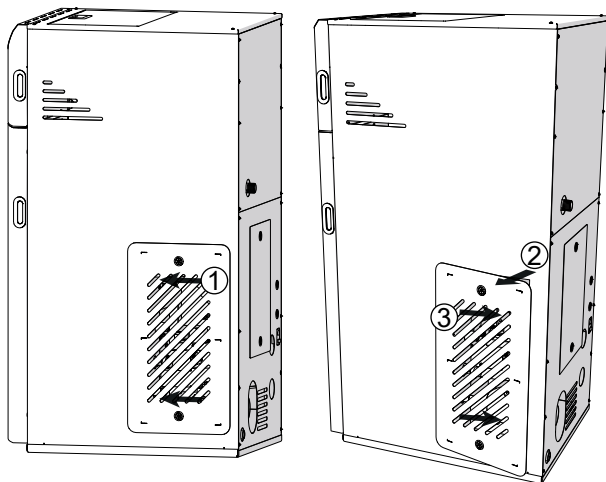

4. Press the temperature limiter STB

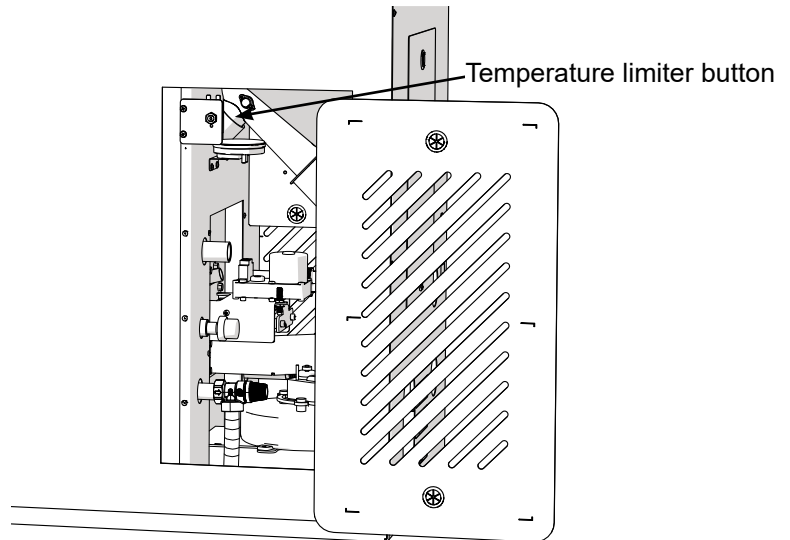

5. Reinstall the cover.
6. Connect the boiler's power cables.
7. Start the control panel.

Resetting of the feeder temperature limiter

The feeder temperature limiter is located under the right inspection cover on the feeder pipe. The limiter resets itself when the temperature drops.

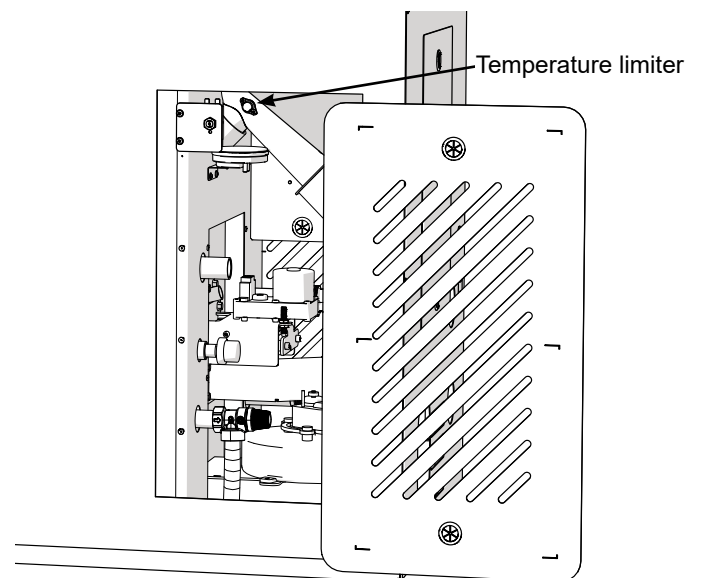

CAUTION
STB may be reset only when the boiler has cooled down. If the boiler temperature is still high, STB will not reset. This applies to boiler STB and feeder temperature limiter.

Cleaning



CAUTION

Always disconnect the boiler power supply before its inspection and cleaning!

Remove soot and ash from the boiler on a regular basis.

Cleaning procedure

Before cleaning, ensure that the boiler has cooled down and is disconnected from the mains.

The boiler has a mechanical system for removing soot from the convection section.

To remove the soot layer, pull the handle located behind the top door of the device. The soot layer accumulated on the walls of the convection channels will be scraped off them and will fall into the service chamber.

This operation must be carried out each time the ash container is cleaned.

The removed soot from the boiler convection ducts accumulates in the service chamber. To clean it, remove the ash container and then clean the chamber.

It is also possible to automatically clean the convection channels after installing the automatic cleaning mechanism. This is an additional option available as an accessory.



CAUTION

The ash may still contain smoldering fuel particles. When emptying the ash pan, use protective clothing and store the ash in a non-flammable container.

Mechanical cleaning system

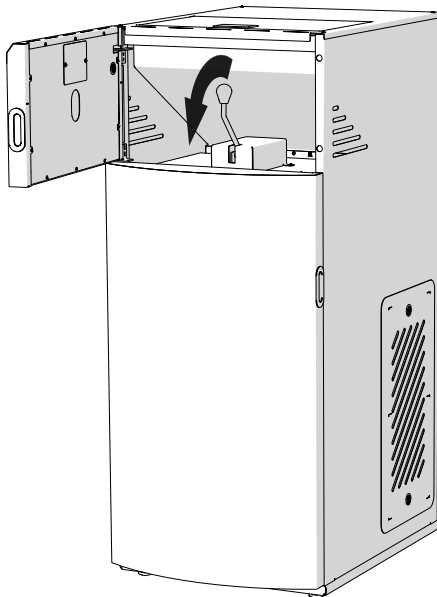

Cleaning the service chamber

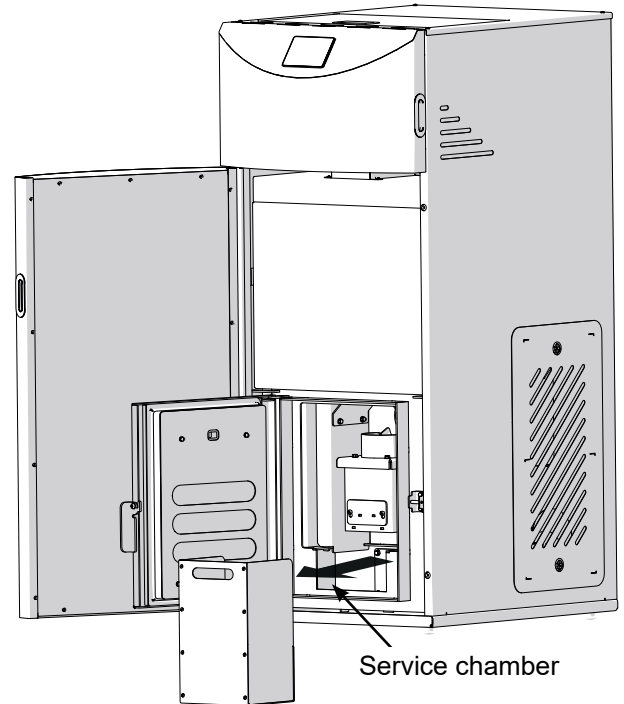

Cleaning the burner grate

To carry out the process of manual burner cleaning, follow these steps:

- Begin the process of extinguishing the flame and wait for its completion until the display shows "Boiler off" on the controller,
- turn off the power and wait until the burner cools down to avoid burns,
- unscrew the 4 fastening screws and remove the burner housing,
- scrape the shelf and the burner grate and clean the holes in the grate,
- if necessary, clean the funnel and the air chamber,
- remove the ash from the burner and the boiler,
- mount the burner housing.

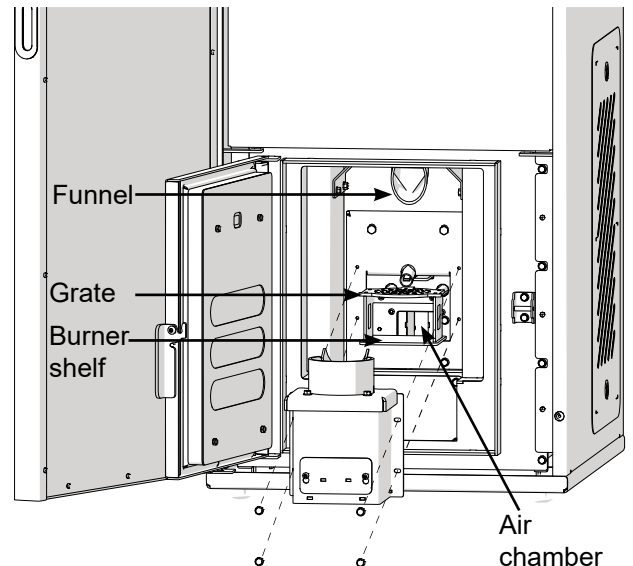

Cleaning the exhaust fan

To carry out the process of manual cleaning of the exhaust fan:

- Begin the process of extinguishing the flame and wait for its completion until the display shows “Boiler off” on the controller,
- turn off the power and wait until the burner cools down to avoid burns,
- unscrew 4 fastening screws and remove the fan cover,
- clean the fan and the connection elbow with a vacuum cleaner,
- fit the fan cover.

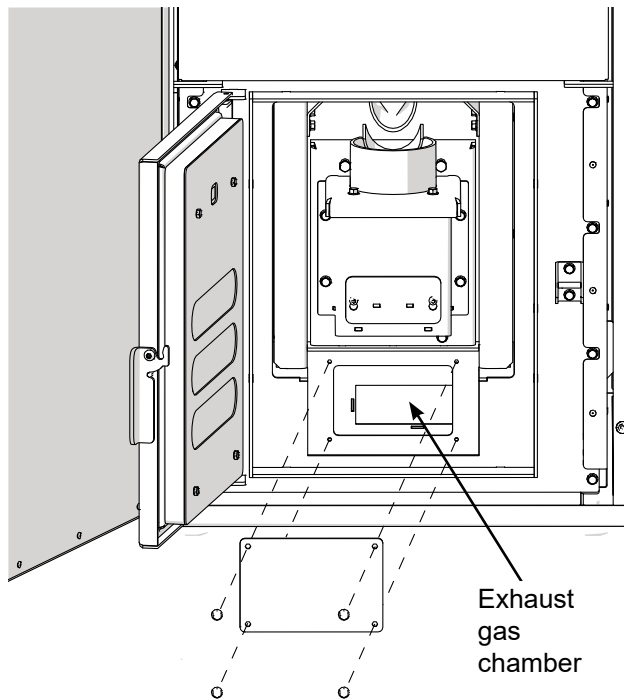
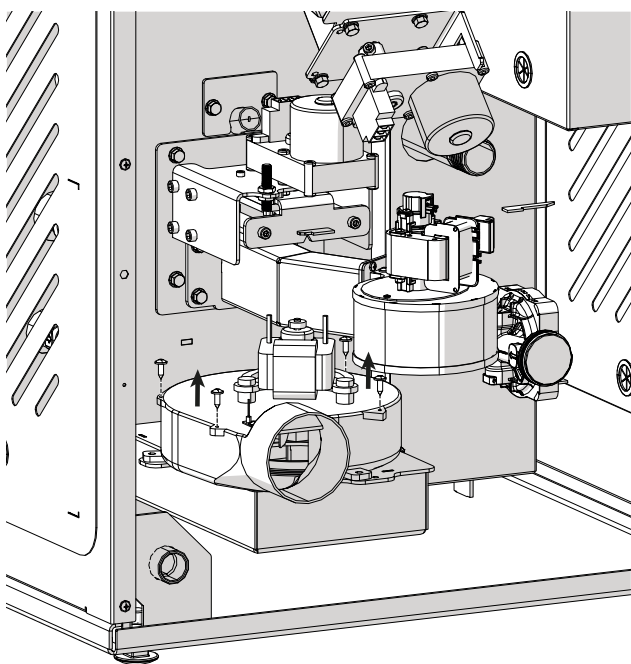

To clean the bottom of the hopper, follow these steps:

- turn off the power and wait until the burner cools down,
- open the inspection cover at the back of the boiler,
- unscrew the 6 wing nuts and remove the cover,
- clean the bottom of the hopper from all debris.

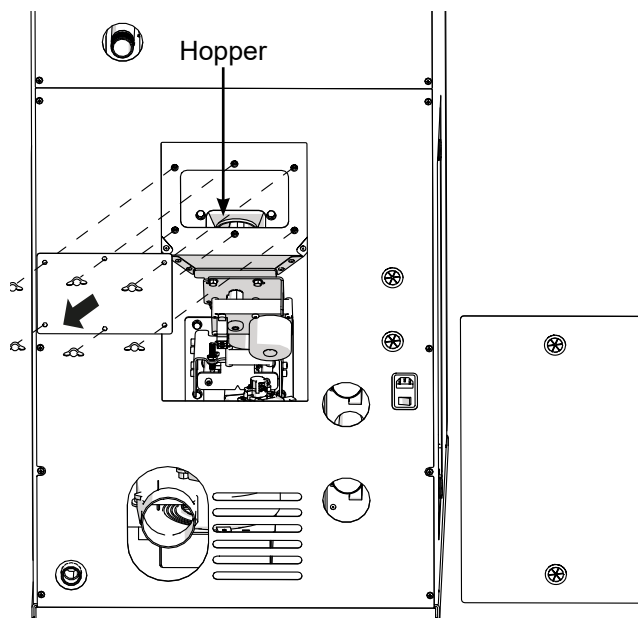

Periodic cleaning of the boiler

Periodic cleaning of the boiler should take place at least twice a year, including mandatory cleaning before the start of the heating season.

During periodic cleaning of the boiler, clean the mounting surface of the turbulators and the lower flue gas chamber.

Periodically clean the pellet storage bin from sawdust, fine pellets and dust.

In order to perform the manual cleaning of the exhaust gas chamber, perform the following steps:

- Begin the process of extinguishing the flame and wait for its completion until the display shows “Boiler off” on the controller,
- turn off the power and wait until the burner cools down to avoid burns,
- remove the ash container,
- unscrew 4 screws and remove the chamber cover,
- clean the chamber with a vacuum cleaner.

CAUTION
Cleaning should be performed only after the pellet storage bin is completely empty or when there is a minimum amount of fuel in the container.

CAUTION
Before a longer break in using the boiler, empty the pellet storage bin to avoid pellet scaling.

To manually clean the turbulators mounting surfaces, follow these steps:

- Begin the process of extinguishing the flame and wait for its completion until the display shows "Boiler off" on the controller,
- turn off the power and wait until the burner cools down to avoid burns,
- open the top cover of the boiler,
- unscrew the handle, then unscrew 4 bolts securing the mechanism housing and remove it (pos. 1),
- remove the cover (pos. 2),
- remove the handle of the cleaning mechanism (pos. 3 and 4),
- unscrew 10 screws and remove the turbulators cover, clean the exposed surface with a vacuum cleaner (pos. 5).

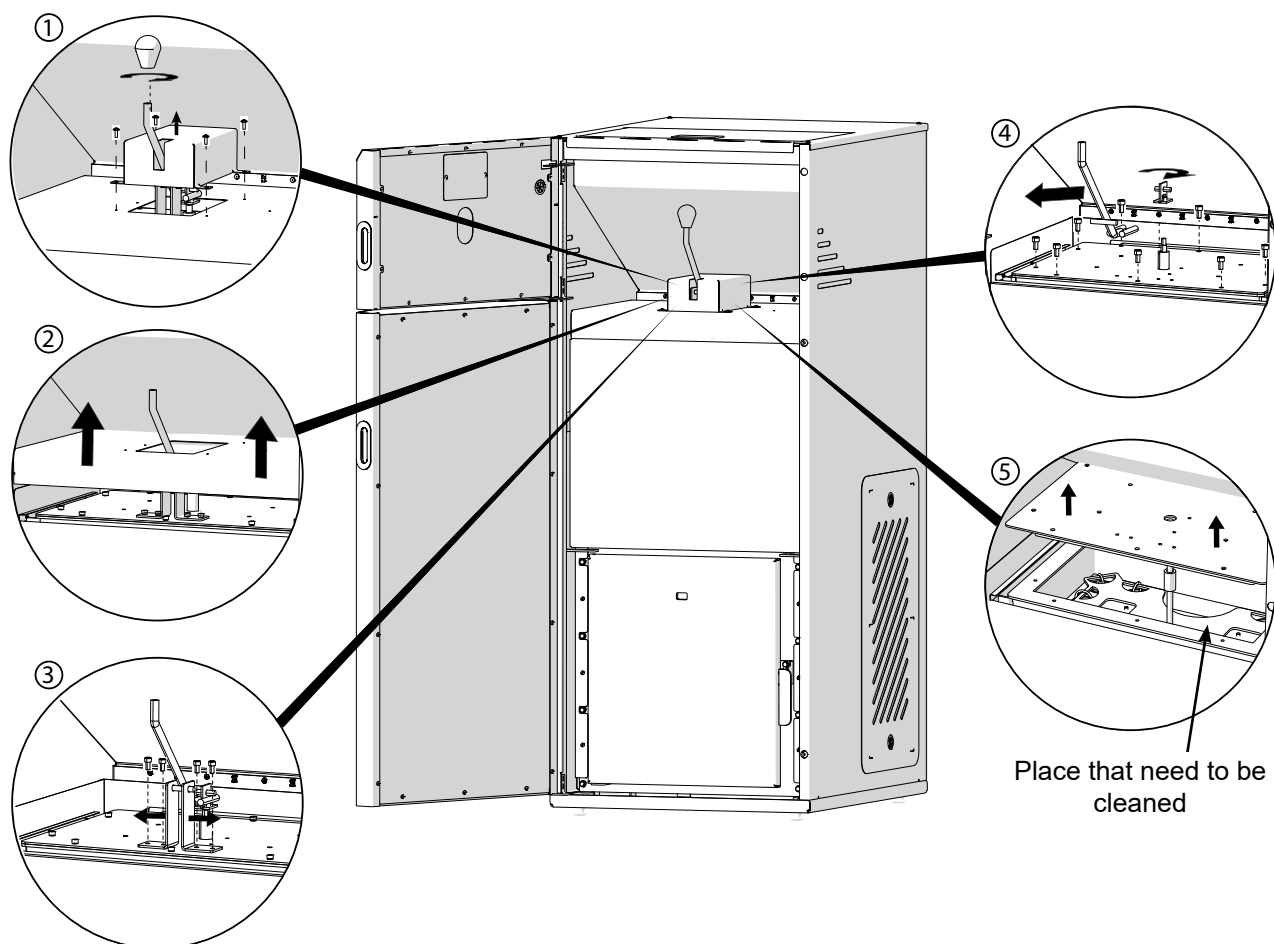

Alarms

| Alarm | Description |
|-------------------------------|---|
| Max. temp. of boiler exceeded | Protection against overheating has two stages. In stage one, i.e. after exceeding the boiler cooling temperature, the controller tries to decrease the temperature by discharging the heat excess to the HUW tank and by opening the mixing valve actuators (only if the mixer control = CH ON). If the temp measured by the HUW sensor the HUW Max Temp value, the HUW pump is switched OFF in order to protect the users against scalding. If the boiler temp decreases, the controller returns to normal operation. However, if the temperature is still decreasing (i.e. reaches 95°C), the permanent alarm for the boiler overheating linked with sound indication is activated. The boiler operation will be stopped. |
| Fan damaged | This alarm occurs at a damage to the speed sensor or the air blower itself, basing on the load voltage on the air blower controlling output. The controller switches the air blower OFF. |
| Boiler sensor damage | This alarm occurs at a damage to the boiler temperature sensor and at exceeding the measuring range of this sensor. Check the sensor and replace it, if required. |
| Firing-up attempt failure | This alarm occurs after the third unsuccessful attempt to fire up the furnace in auto mode. The causes of this alarm can be the following: damaged igniter or air blower, damage to the fuel supply system, incorrect parameters set, poor fuel quality and/or lack of fuel in the dispenser. Before continuing, check whether no excessive unfired fuel has accumulated in the furnace. If this is the case, remove any fuel excess. Firing up with fuel excess can lead to the explosion of flammable gases. |
| STB activated | This alarm occurs at tripping of an independent safety thermostat protecting the boiler against overheating. The burner is switched OFF. After the boiler temperature drops, the limiter should be reset in accordance with the instructions on page 47. |
| Broken feeder fuel system | The alarm will occur when the feeder output in the main boiler module is damaged. Module A should be checked or replaced if necessary. |
| Minimum vacuum exceeded | The alarm will occur in the absence of the required vacuum in the combustion chamber. The reason may be an open boiler door during operation, leakage, or damage to the vacuum sensor. The alarm will occur 30 seconds after the set minimum value has fallen, therefore the door should not be opened while the boiler is operating. |
| Maximum pressure exceeded | The vacuum in the boiler has exceeded the maximum set value in the service menu. The boiler goes into the BURNING OFF mode. |
| Maximum pressure exceeded | The alarm will occur when the water pressure in the boiler exceeds the maximum value. The boiler goes into the BURNING OFF mode. |
| Exhaust fan damaged | The alarm will occur when the regulator does not read the exhaust fan revolutions. This can happen when the rotation sensor or the fan itself is damaged. |
| Grate blocked | The alarm will occur when the burner cleaning mechanism is blocked. First, check the cleanliness of the burner grate. |
| Vacuum sensor damaged | Sensor failure. Damage to the sensor cable. |
| Max. temp. of fumes exceeded | The exhaust gas temperature has exceeded the maximum value. |
| Fumes sensor damage | Sensor failure. Damage to the sensor cable. |

15 Wiring Diagrams

Boiler

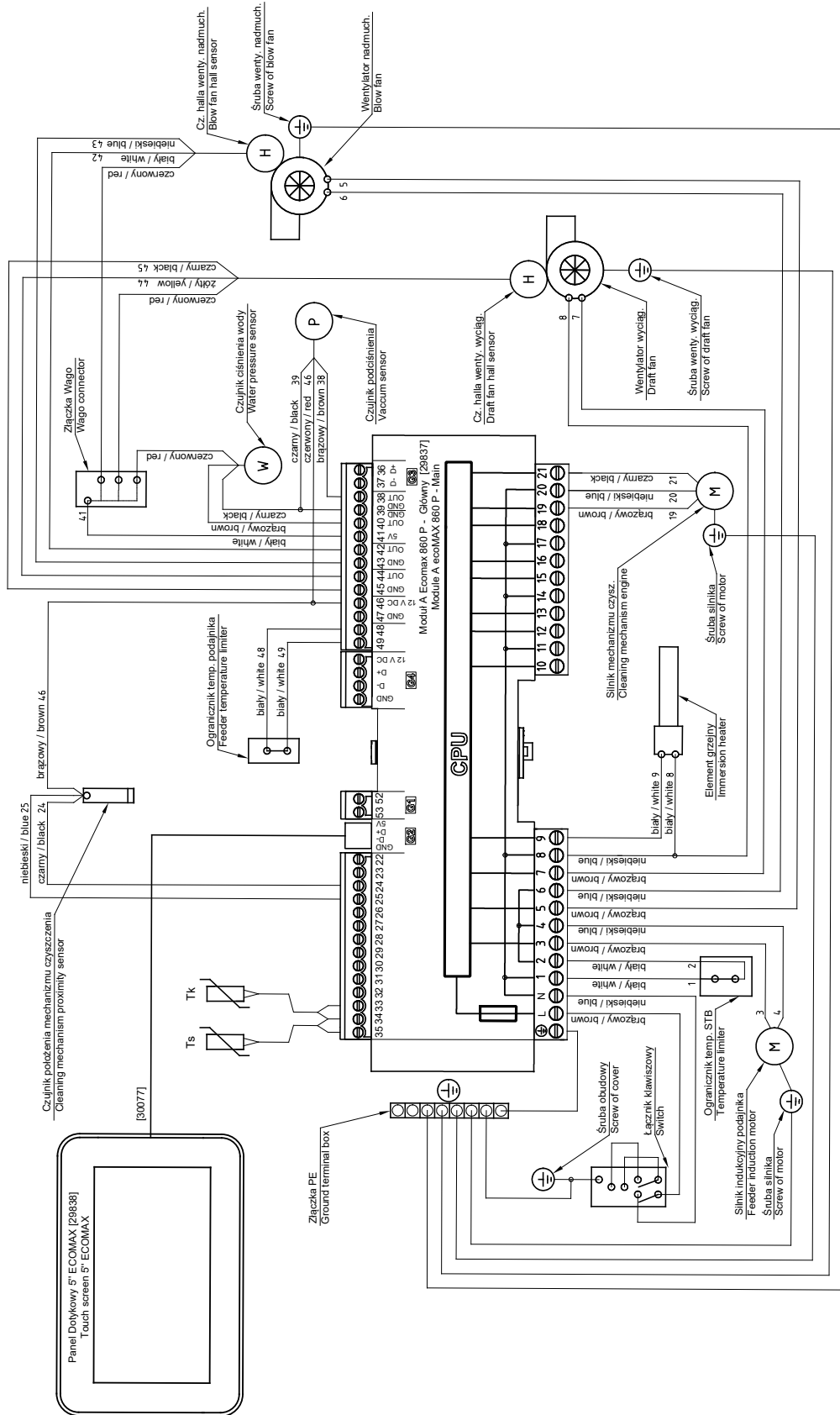

UWAGA:

- 2 - oznacza numer gniazda, do którego należy wpiąć przewód / number of slot where we should connect cable
- 1 - numer gniazda na module wykonawczym / slot number on the module
- [30077] - numer katalogowy / article number

16 Location of Components

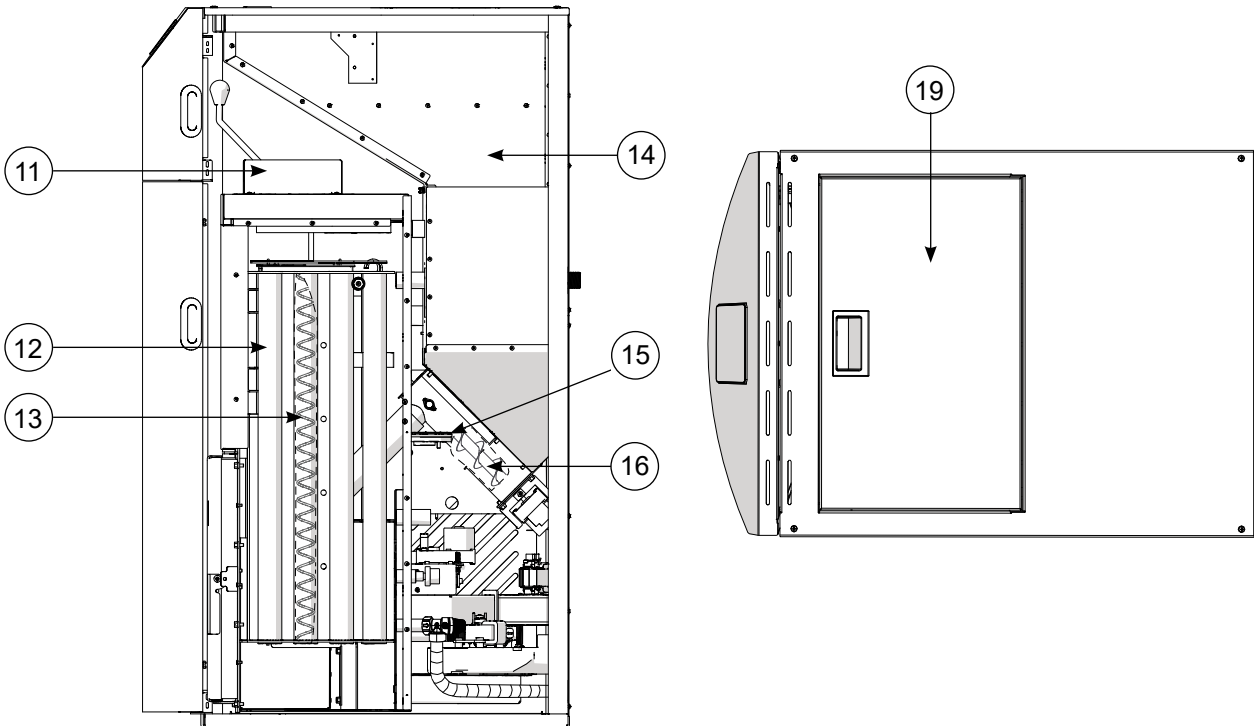
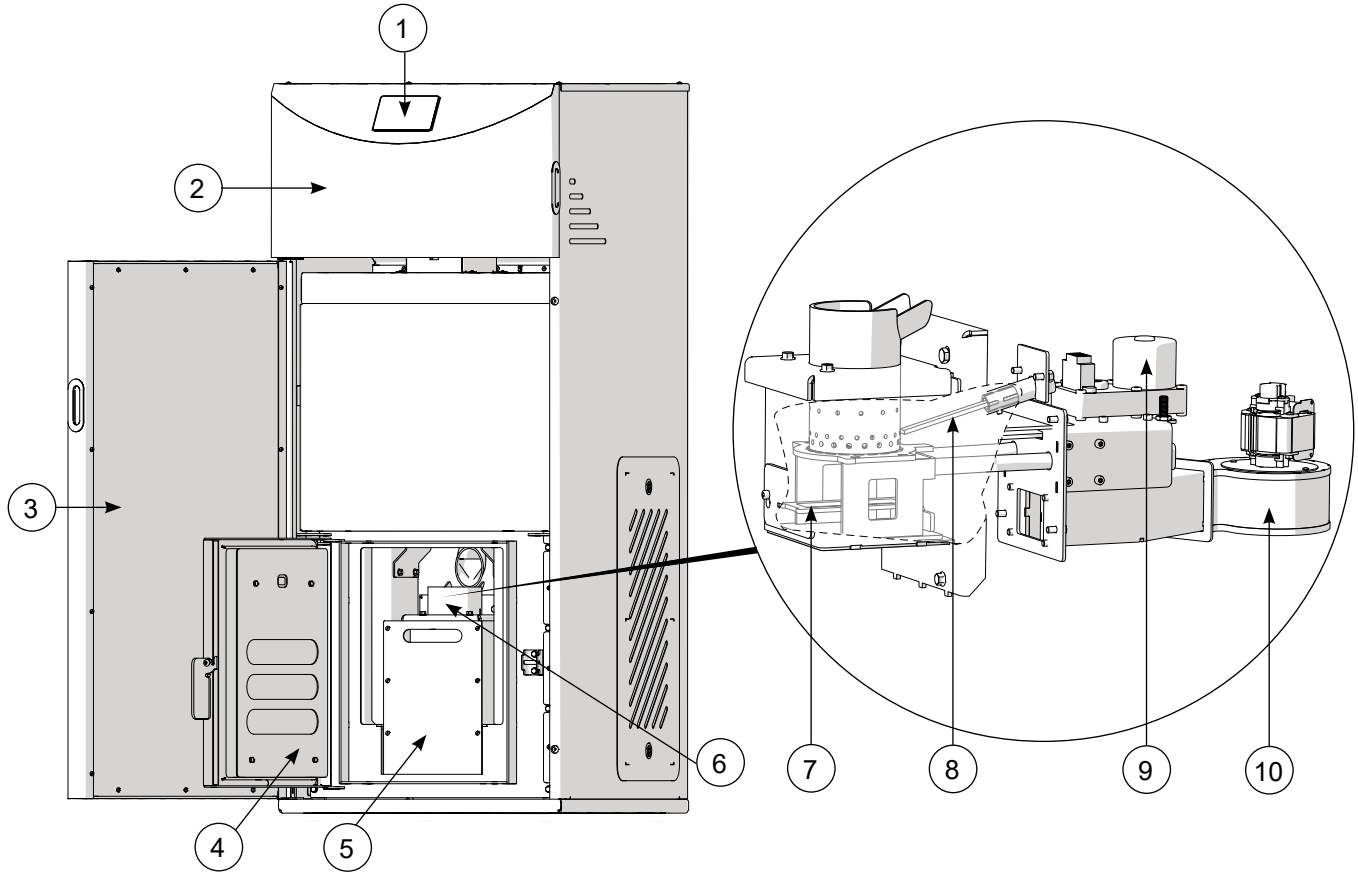

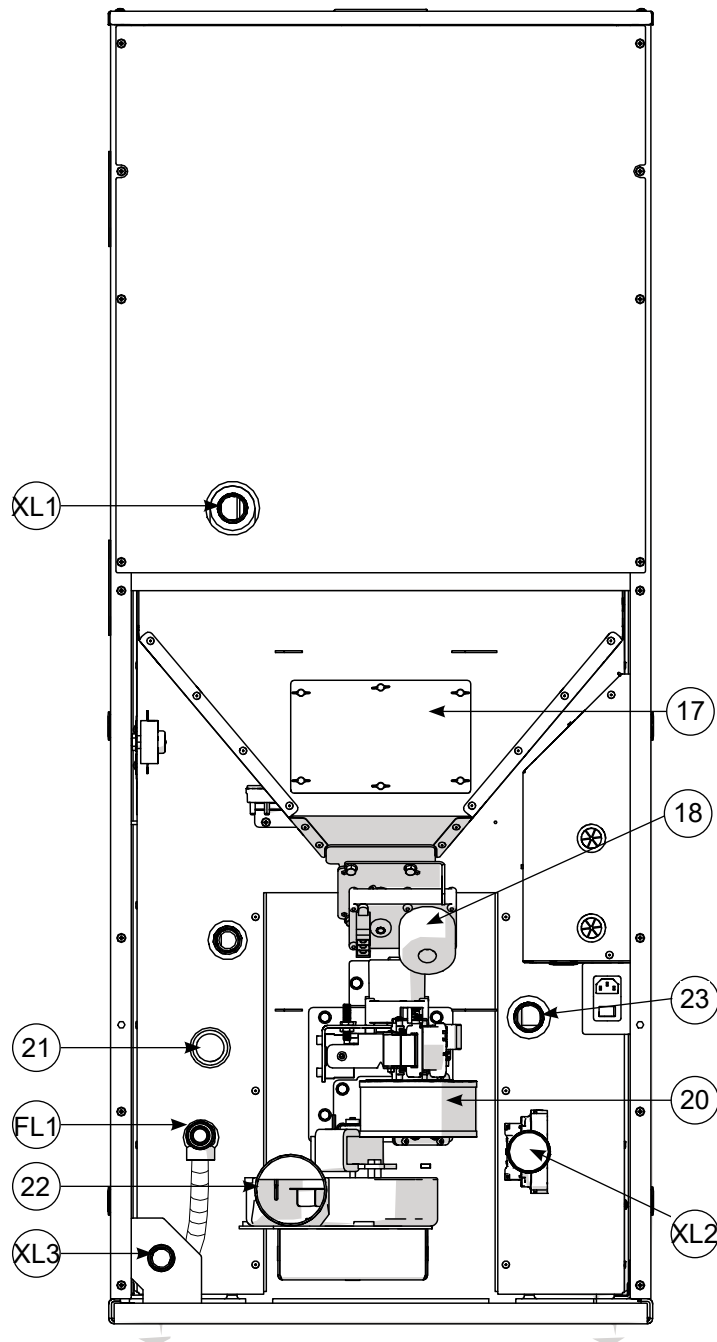

List of components:

- | | |
|---|---|
| <ul style="list-style-type: none"> 1. Boiler regulator (operator panel) 2. Boiler upper door. 3. Boiler lower door. 4. Combustion chamber door. 5. Ash container. 6. Burner. 7. Burner cleaning mechanism. 8. Electric heater. 9. Actuator. 10. Blower fan. 11. Convection ducts cleaning mechanism. 12. Flue gas turbulators. 13. Convection ducts. 14. Pellet storage bin. 15. Transport pipe. | <ul style="list-style-type: none"> 16. Feeder spiral. 17. Storage bin inspection cover. 18. Feeder gearmotor. 19. Storage bin cover. 20. Blower fan. 21. Water pressure sensor. 22. Exhaust gas outlet / exhaust fan. 23. Additional connection (XL). XL1 Auxiliary CH heating water supply connection. XL2 CH heating water return connection (pump in the device). XL3 Blowdown connection. FL1 Safety valve with drain line. |
|---|---|

Electrical Components

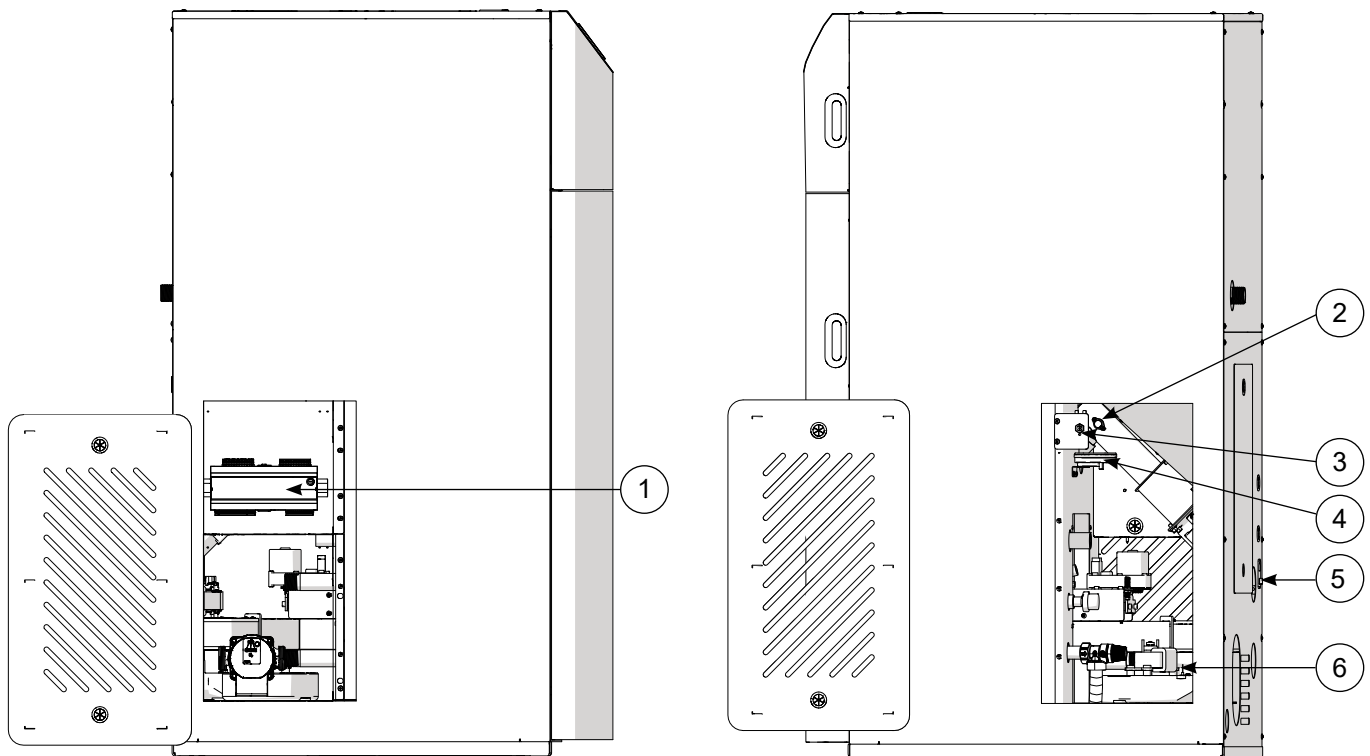

List of electrical components:

1. Boiler primary module.
2. Feeder temperature limiter.
3. Boiler temperature limiter.
4. Pressure sensor in the combustion chamber.
5. Main ON/OFF switch.
6. Exhaust gas temperature sensor.

17 Dimensions

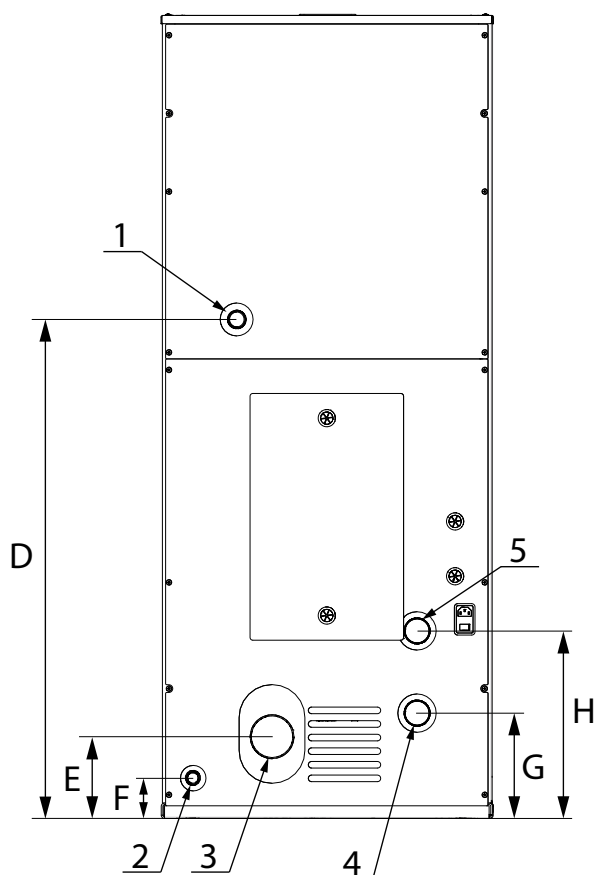
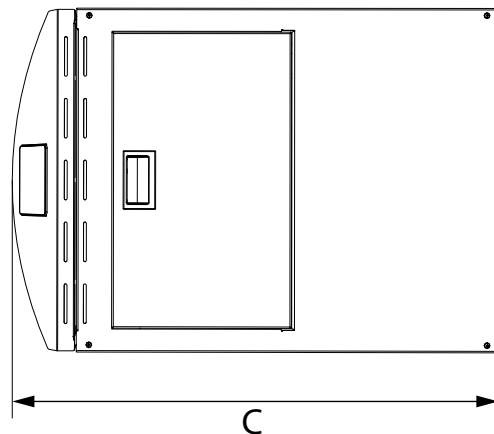
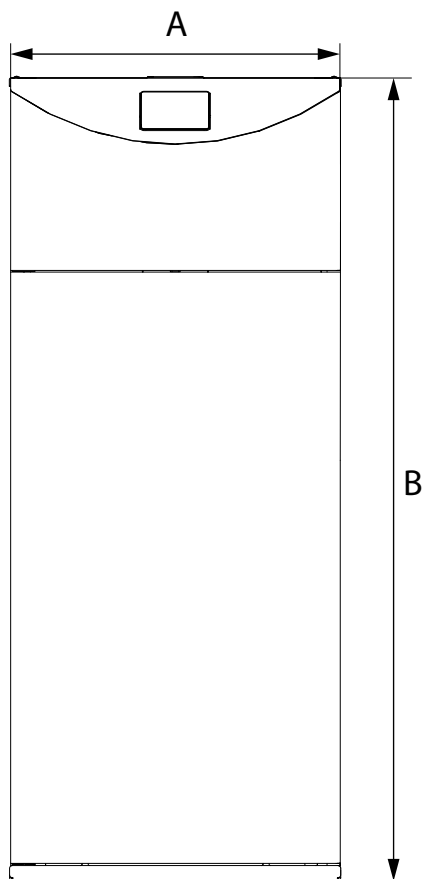

| Symbol | Dimensions | |
|--------|----------------|----------------|
| | Pellux Slim 12 | Pellux Slim 18 |
| A | 600 mm | |
| B | 1464 mm | |
| C | 865 mm | |
| D | 910 mm | |
| E | 149 mm | |
| F | 73 mm | |
| G | 192 mm | |
| H | 342 mm | |

| Connection number | Diameter |
|-------------------|-------------------|
| | Pellux Slim 12-18 |
| 1 | G1" |
| 2 | G 3/4" |
| 3 | ø 80 mm |
| 4 | G1" |
| 5 | G1" |

19 Technical Specifications



| Parameter | Pellux Slim 12 | Pellux Slim 18 |
|---|--------------------------|---------------------------|
| Boiler class | 5 | 5 |
| Rated power | 12,17 kW | 18,46 kW |
| Net weight | 320 kg | 320 kg |
| Pellet storage bin capacity | 100 kg | 100 kg |
| Water capacity | 38 l | 38 l |
| Power supply | 230/50 V/Hz | |
| Boiler efficiency | 94,95 % | 95,55 % |
| Seasonal efficiency | 84,61 % | 84,66 % |
| Operating temp max | 80 °C | |
| Return temp min (at the boiler inlet) | 55 °C | |
| Flue gas temp | 80-150 °C | |
| Noise level | 46 dB | |
| Exhaust outlet pipe diameter | ø 80 mm | ø 80 mm |
| Pressure max | 2 bar | |
| Flue gas draught required | 12 Pa | 12 Pa |
| Fuel | ø 6-8 mm | |
| Degree of protection | IP21 | |
| Chimney diagonal | 130 x 130 / ø130 mm | |
| Power consumption in standby mode | 1 W | 1 W |
| Power consumption at nominal power | 90 W | 90 W |
| Power consumption at minimal power | 40 W | 40 W |
| Flue gas mass flow – at rated power | 1,76 m/s | 1,81 m/s |
| Flue gas mass flow – at min power | 1,71 m/s | 1,73 m/s |
| Pressure drop at the boiler – Δ10 °C | (-101 mbar) | (-102 mbar) |
| Pressure drop at the boiler – Δ20 °C | (-97 mbar) | (-98 mbar) |
| CO at 10% O ₂ * | 60,07 mg/Nm ³ | 107,91 mg/Nm ³ |
| OGC at 10% O ₂ * | 11,30 mg/Nm ³ | 5,13 mg/Nm ³ |
| Dust at 10% O ₂ * | 15,36 mg/Nm ³ | 15,28 mg/Nm ³ |
| NO _x at 10% O ₂ * | 98,58 mg/Nm ³ | 103,79 mg/Nm ³ |

* according to research „ITEM -Consult” Ltd. Sofia 1220, bul. Istoriq Slavqnobulgarska No.8 - Research report nr 167/21.04.2020

PELLUX

NIBE-BIAWAR Sp. z o.o.

al. Jana Pawła II 57
15-703 Białystok

tel. 85 662 84 90,
fax 85 662 84 09

sekretariat@biawar.com.pl
www.pellux.com.pl
www.biawar.com.pl